



# AIRDOG USER MANUAL

Airdog User Manual V.2  
April, 2016

We will be adding more content to this user manual over time as we receive feedback from users and develop new functions. Please check our website on a regular basis for user manual updates.

# Table Of Contents

---

|  |           |
|--|-----------|
| <b>Chapter 1: Before You Begin</b> .....   | <b>5</b>  |
| 1.1 Read Before The First Flight .....   | <b>5</b>  |
| 1.2 General Overview .....   | <b>5</b>  |
| 1.3 Safety Guidelines For Small Unmanned Aircraft<br>Systems (sUAS) Recreational Users ..... | <b>6</b>  |
| 1.4 Unmanned Aircraft Systems (UAS) Registration .....                                       | <b>7</b>  |
| 1.5 AirDog Mobile App Specifications .....   | <b>8</b>  |
| 1.6 AirDog Desktop App Specifications .....  | <b>8</b>  |
| 1.7 What's In The Box .....  | <b>9</b>  |
| <b>Chapter 2: AirDog Support</b> .....   | <b>10</b> |
| <b>Chapter 3: Get To Know AirDog</b> .....   | <b>11</b> |
| 3.1 About Us .....   | <b>11</b> |
| <b>Chapter 4: General Overview</b> .....   | <b>12</b> |
| 4.1 AirDog Drone Overview .....  | <b>12</b> |
| 4.1.1 Motors And Propellers .....  | <b>12</b> |
| 4.1.2 Battery .....  | <b>12</b> |
| 4.1.3 Gimbal .....   | <b>12</b> |
| 4.1.4 Fold-Up Arms .....   | <b>13</b> |
| 4.2 AirLeash Wearable Controller Overview .....  | <b>14</b> |
| 4.2.1 AirLeash Display .....   | <b>14</b> |
| 4.2.2 AirLeash Icons .....   | <b>14</b> |
| 4.2.3 AirLeash Buttons .....   | <b>16</b> |
| 4.2.4 AirLeash LEDs .....  | <b>18</b> |
| 4.2.5 AirLeash Strap .....   | <b>19</b> |

|   |           |
|---|-----------|
| 4.3 Battery Overview .....                            | 19        |
| 4.3.1 Level Indicator .....                           | 19        |
| 4.3.2 Battery Operation Modes .....                   | 21        |
| 4.3.3 Firmware Update .....                           | 21        |
| 4.3.4 Error And Status Codes .....                    | 22        |
| 4.3.5 Battery Recovery Process .....                  | 23        |
| 4.3.6 Battery Charger And AC Wall Plug Adapters ..... | 24        |
| 4.4 Mobile App Overview .....                         | 25        |
| 4.5 AirLoader Desktop App Overview .....              | 26        |
| 4.6 Sport Modes .....                                 | 26        |
| 4.6.1 Sport Mode Descriptions .....                   | 27        |
| 4.6.2 Follow Modes .....                              | 30        |
| 4.6.3 Landing Modes .....                             | 33        |
| <b>Chapter 5: System Preparation .....</b>            | <b>35</b> |
| 5.1 AirDog .....                                      | 35        |
| 5.1.1 Unfolding The Arms .....                        | 35        |
| 5.1.2 Attaching The Landing Gears .....               | 36        |
| 5.1.3 Attaching The Propellers .....                  | 37        |
| 5.1.4 Recommended GoPro Settings .....                | 39        |
| 5.1.5 Mounting The Camera .....                       | 40        |
| 5.1.6 Inserting The Battery .....                     | 41        |
| 5.2 Battery .....                                     | 42        |
| 5.2.1 Charging The Battery .....                      | 42        |
| 5.2.2 General Guidelines And Warnings .....           | 43        |
| 5.2.3 Before Using The Battery .....                  | 44        |
| 5.2.4 Storage And Transportation .....                | 44        |
| 5.2.5 Battery Disposal .....                          | 45        |

# Table Of Contents

---

|   |           |
|---|-----------|
| 5.3 AirLeash .....  | 45        |
| 5.3.1 Charging AirLeash .....                                   | 45        |
| 5.3.2 Pairing With AirDog .....                                 | 46        |
| 5.3.3 Strapping AirLeash .....                                  | 47        |
| 5.4 AirDog Mobile App .....                                     | 48        |
| 5.4.1 Download And Install AirDog app .....                     | 48        |
| 5.4.2 Activation Of AirDog .....                                | 49        |
| 5.4.3 How To Customize A Sport Mode Via AirDog Mobile App ..... | 49        |
| 5.5 GPS .....   | 51        |
| 5.6 Calibration .....   | 51        |
| 5.6.1 AirLeash Calibration .....                                | 51        |
| 5.6.1.1 AirLeash Magnetometer (Mag) Calibration .....           | 52        |
| 5.6.1.2 AirLeash Accelerometer (Accels) Calibration .....       | 56        |
| 5.6.1.3 AirLeash Gyroscope (Gyro) Calibration .....             | 59        |
| 5.6.2 AirDog Calibration .....                                  | 61        |
| 5.6.2.1 AirDog Magnetometer (Mag) Calibration .....             | 61        |
| 5.6.2.2 AirDog Accelerometer (Accels) Calibration .....         | 65        |
| 5.6.2.3 AirDog Gyroscope (Gyro) Calibration .....               | 70        |
| 5.6.3 Gimbal Calibration .....                                  | 72        |
| 5.6.3.1 Gimbal Gyroscope (Gyro) Calibration .....               | 72        |
| 5.6.3.2 Gimbal Accelerometer (Accels) Calibration .....         | 73        |
| <b>Chapter 6: Safety .....</b>                                  | <b>76</b> |
| 6.1 Know Your Surroundings And Flight Safety .....              | 76        |
| 6.1.1 Pre-Flight Checklist .....                                | 76        |

|   |           |
|---|-----------|
| 6.1.2 Pre-Flight Requirements .....                               | 77        |
| 6.1.3 Flight Location & Prohibited Takeoff Locations .....        | 77        |
| 6.1.4 Flight Limits .....   | 78        |
| 6.1.5 Laser Warning .....   | 78        |
| <b>Chapter 7: Flight .....</b>                                    | <b>79</b> |
| 7.1 Before Flight .....   | 79        |
| 7.1.1 Sensor Check .....  | 81        |
| 7.2 Takeoff .....   | 85        |
| 7.3 AirDog Inflight Controls Via AirLeash .....                   | 86        |
| 7.3.1 Altitude Adjustment .....                                   | 86        |
| 7.3.2 Angle Adjustment .....                                      | 86        |
| 7.3.3 Farther & Closer .....                                      | 87        |
| 7.3.4 Play / Pause Follow .....                                   | 88        |
| 7.3.5 Come To Me (CTM) .....                                      | 88        |
| 7.4 Landing .....   | 89        |
| <b>Chapter 8: Software Update via Desktop app AirLoader .....</b> | <b>90</b> |
| <b>Chapter 9: Appendix .....</b>                                  | <b>91</b> |
| 9.1 Specifications .....  | 91        |
| 9.2 Warranty .....  | 93        |
| 9.2.1 What Is Covered and For How Long? .....                     | 93        |
| 9.2.2 What Is Not Covered? .....                                  | 94        |
| 9.3 Compliance .....  | 95        |
| 9.3.1 FCC Compliance .....  | 95        |
| 9.3.2 IC RSS Compliance .....                                     | 97        |
| 9.3.3 EC Declaration Of Conformity .....                          | 98        |
| 9.4 Manufacturer’s Disclaimer Statement .....                     | 100       |

# 1. Before You Begin

---

## 1.1 Read Before The First Flight

Before operating AirDog please read the following documents thoroughly, follow all instructions and retain it for future reference:

- A. AirDog User Manual
- B. AirDog Safety Guidelines, Disclaimer And Warranty

## 1.2 General Overview

First of all, thanks for joining in AirDog's vision and being an early adopter of auto-follow drone technology, developed by a small team of passionate and adventurous engineers and entrepreneurs. The World's First Auto-follow Drone for Action Sports is in your hands and we hope it will empower you to go out and create new stories around your actions. Because of people like you we were able to innovate and develop a new technology never before seen. After our success on Kickstarter, "auto-follow" or "follow me" have become standard features in many drones and we are proud to have made such impact in the industry. For AirDog, following is not a feature but its core essence. It will follow and film you in many different ways, because every sport is different so we've custom engineered auto-follow flight modes for various action sports. Be careful and always pay close attention to the selected sport flight mode to ensure the sport flight mode matches your sport. AirDog is future proof and will become even more capable and intelligent over time as we continue to improve the software.

AirDog has many built-in preflight and in-flight safety checks to avoid crashing. The main rule you have to follow is to operate AirDog **ONLY IN WIDE OPEN AREAS** where there is no risk of colliding into people and obstacles such as trees, steep mountains, buildings and construction. This is especially important until you gain experience and a better understanding of how different flight modes and AirDog operates.

To achieve AirDog’s performance we fuse data from many sensors such as accelerometers, gyroscopes, magnetometers, GPS and barometers both in AirDog and AirLeash. Please be gentle while operating, transporting and storing all equipment. Avoid dropping, hard shocks, moisture, and strong magnets.

This is the first product of its kind, so your feedback, observations, opinions and suggestions are highly appreciated. Please use the Support or Forum section on our website to get in touch with us and other AirDog users. To have the best user experience please read this “User Manual” in its entirety before you go out and fly. And remember that if you need assistance we are always reachable. Have fun!

## 1.3 Safety Guidelines For Small Unmanned Aircraft Systems (sUAS) Recreational Users

### What are the safety guidelines for sUAS recreational users?

- Follow community-based safety guidelines, as developed by organizations such as the Academy of Model Aeronautics (AMA).
- Fly no higher than 400 feet (120 meters) and remain below any surrounding obstacles when possible.
- Keep your sUAS in eyesight at all times, and use an observer to assist if needed.
- Remain well clear of and do not interfere with manned aircraft operations, and you must see and avoid other aircraft and obstacles at all times.
- Do not intentionally fly over unprotected persons or moving vehicles, and remain at least 25 feet (7 meters) away from individuals and vulnerable property.
- Contact the airport or control tower before flying within five miles (8 km) of an airport.
- Fly no closer than two nautical (4 km) miles from a heliport with a published instrument flight procedure.
- Do not fly in adverse weather conditions such as in high winds or reduced visibility.
- Do not fly under the influence of alcohol or drugs.
- Ensure the operating environment is safe and that the operator is competent and proficient in the operation of the sUAS.

# 1. Before You Begin

---

- Do not fly near or over sensitive infrastructure or property such as power stations, water treatment facilities, correctional facilities, heavily traveled roadways, government facilities, etc.
- Check and follow all local laws and ordinances before flying over private property.
- Do not conduct surveillance or photograph persons in areas where there is an expectation of privacy without the individual's permission (see AMA's privacy policy).

Users of commercial and recreational UAS should be aware that in remote, rural and agricultural areas, manned aircraft, including fixed-wing aircraft and helicopters, may be operating very close to ground level. Pilots conducting agricultural, firefighting, law enforcement, emergency medical, wildlife survey operations and a variety of other services all legally and routinely work in low-level airspace. Operators controlling UAS in these areas should maintain situational awareness, give way to, and remain a safe distance from these low-level, manned airplanes and helicopters.

Source: [knowbeforeyoufly.org](http://knowbeforeyoufly.org)

AirDog supports the Know Before You Fly education campaign and is committed to providing consumers and prospective business operators of unmanned aircraft systems the tools to know how to fly safely and responsibly before taking to the skies.

## 1.4 Unmanned Aircraft Systems (UAS) Registration

If you own a drone, you must register it with the Federal Aviation Administration's Unmanned Aircraft System (UAS) registry. A federal law effective December 21, 2015 requires unmanned aircraft registration, and you are subject to civil and criminal penalties if you do not register. For Unmanned Aircraft Systems Registration process, go to: [www.faa.gov/uas/registration](http://www.faa.gov/uas/registration)



## 1.5 AirDog Mobile App Specifications

Download the free AirDog mobile app from the Apple App Store for your iPhone or from Google Play for your Android phone.

Supported Operating Systems and Devices:

### Apple

AirDog app can be used with iPhone (6s Plus, 6s, 6 Plus, 6, 5s, 5c, 5 & 4s), iPad (Pro, Air - all models, Mini - all models, 3rd & 4th gen), iPod touch. Supported operating systems: iOS 8 and newer.

### Android

AirDog app for Android is supported on devices that support Bluetooth Low Energy (BLE) profile and run Android versions: 4.3 to 5.1



Download and install the app on your device before the first flight. The app is compatible with AirDog only.

## 1.6 AirDog Desktop App Specifications

Download the free AirDog desktop app from our web page:  
[www.airdog.com/support](http://www.airdog.com/support)

Supported Operating Systems:

### Mac OS X

AirLoader desktop app can be installed on: 10.10 "Yosemite", 10.11 "El Capitan".

### Microsoft Windows

AirLoader desktop app can be installed on: Windows 7, 8, 8.1, 10.

### Linux

AirLoader desktop app can be installed on Ubuntu 12.04 or newer versions.



Download and install AirLoader desktop app on your device before the first flight. These applications are compatible with AirDog only.

# 1. Before You Begin

---

## 1.7 What's In The Box



AirDog auto-follow drone (1x unit)\*



AirLeash (1x unit)  
Strap (1x unit)



Battery (1x unit)



Battery charger (1x unit)



USB wall adapter (1x unit)\*\*



Micro USB cable (1x unit)



Power cord (1x unit)\*\*

---

\*GoPro camera and GoPro camera housing not included.

\*\*US and EU adapters included.

## 2. AirDog Support

---

**Quick start videos, tutorials, tips and latest User Manual version:**

at [help.airdog.com](http://help.airdog.com)

**Get your questions answered:**

at [airdog.com/support](http://airdog.com/support) and **email:** [support@airdog.com](mailto:support@airdog.com)

(please allow up to 48 hours for response)

**Website address:** [www.airdog.com](http://www.airdog.com)

**AirDog Forum:** [www.forum.airdog.com](http://www.forum.airdog.com)

**Social Media:**



[facebook.com/airdogteam](https://facebook.com/airdogteam)



[youtube.com/airdogchannel](https://youtube.com/airdogchannel)



[twitter.com/airdogteam](https://twitter.com/airdogteam)



[vimeo.com/airdog](https://vimeo.com/airdog)



[instagram.com/airdogteam](https://instagram.com/airdogteam)



[plus.google.com/+Airdogteam](https://plus.google.com/+Airdogteam)

**Mailing address:** AirDog SIA

Aristida Briana iela 9a-228

1001 Riga, Latvia

© 2016 AirDog, Inc. All Rights Reserved.

AirDog, AirLeash and the AirDog logo are trademarks or registered trademarks of AirDog, Inc.

GoPro, HERO, the GoPro logo, and the GoPro Be a HERO logo are trademarks or registered trademarks of GoPro, Inc.

App Store is a trademark of Apple Inc.

Google Play is a trademark of Google Inc.

Bluetooth is a trademark of Bluetooth SIG, Inc.

All other trademarks mentioned in this user manual are protected and are the property of their respective owners.

# 3. Get To Know AirDog

---

## 3.1 About Us

A fresh powder ride, the best wave of the day, landing a trick. It's these moments that amplify our lives and give us motivation to find action, push our boundaries or just enjoy it all. We believe these moments can truly inspire ourselves and others.

AirDog was born out of a passion for action sports. For each Founder and every AirDog team member it's different – motocross, skateboarding, snowboarding, kitesurfing, wakeboarding, surfing, biking, skiing, anything that gets the adrenaline going and gives us motivation to be bold, push our boundaries and find actions.

We set out to revolutionize how you can capture your actions and created AirDog, the world's first auto-follow drone with action sport flight modes. AirDog enables you to capture yourself in action - easily, without assistance and from any angle. We've reinvented drone controls with AirLeash, and we've researched each and every sport to customize AirDog's sport flight modes to make capturing your actions flawless, effortless and fun. This will change the way you film your actions and share your story.

# 4. General Overview

---

## 4.1 AirDog Drone Overview

AirDog is a small, foldable, autonomous and intelligent flying quadcopter drone. It is designed to follow the user of AirDog, typically in action sports. AirDog will follow the user wearing a small tracking controller device, AirLeash. AirDog will film the user on a mechanically stabilized GoPro HERO camera.

### 4.1.1 Motors And Propellers

AirDog has 4 motors and propellers to generate the lift needed for flight. Front propellers face down and rear propellers face upwards. The front left and rear right propellers spin counter clockwise. The front right and rear left propellers spin clockwise. Propellers are self tightening and can be removed and reattached. AirDog can be folded and transported with propellers attached or removed.

### 4.1.2 Battery

AirDog uses a rechargeable Lithium polymer, 4 cell, 5600mAh battery. Depending on conditions it can stay airborne up to 18 minutes. To ensure safe operation please read section 5.2 on battery use and maintenance.

### 4.1.3 Gimbal

To ensure vibration-free and stable video footage, AirDog has a built-in vibration isolation system and camera gimbal with 2 motors. The Gimbal compensates the movements of AirDog to steady to camera. Panning is achieved by yawing AirDog itself and it is done fully automatic. (see the picture on page 13)

# 4. General Overview

---



- ⓘ In order to avoid signal interference, disable and turn off the WiFi on the GoPro camera before each flight. Do not fly your AirDog with the GoPro WiFi on.
- To start recording, manually turn on the GoPro camera using the power button on the GoPro camera before each flight.
- Compatible Cameras: GoPro HERO3, 3+ and 4 Silver, Black (in Standard Housing).

## 4.1.4 Fold-Up Arms

The arms on AirDog are designed to fold in tightly. This makes it both safer to travel with (as the arms won't break off) and it makes it easy to store in a small case or a backpack.

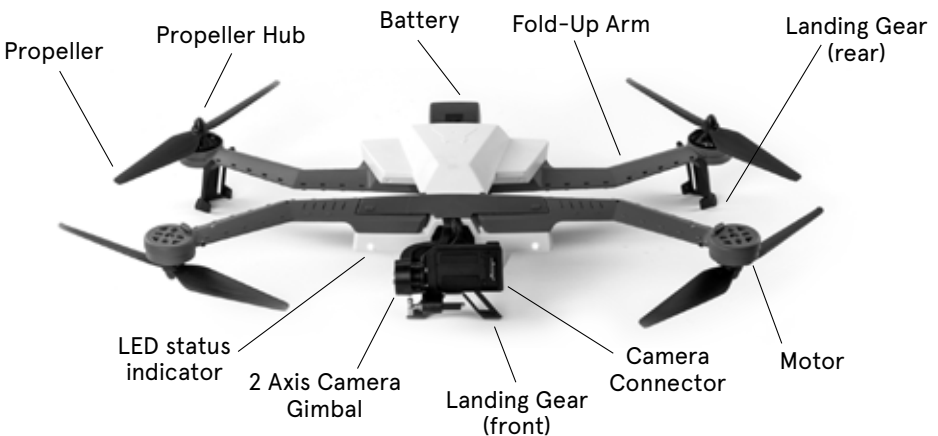

## 4.2 AirLeash Wearable Controller Overview

With long range wireless connectivity, AirLeash is everything you need to guide and control AirDog. Its waterproof design lets you enjoy water sport actions and it only takes a moment to customize the settings.

AirLeash connects to AirDog through a powerful long-range Bluetooth signal, ensuring they stay connected and continue to communicate from a distance or if the user is temporarily submerged under water. AirLeash allows the user to control the positioning of AirDog and the camera angles.

### 4.2.1 AirLeash Display

A display is built into AirLeash allowing you to view and change all current settings and navigate the menu.

1. Information bar. Shows various messages about AirDog's status and selected sport
2. Current selected follow mode
3. AirLeash battery level
4. Current selected landing mode
5. AirDog battery level
6. AirDog GPS signal strength
7. AirLeash GPS signal strength

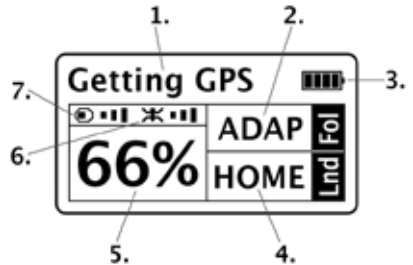















### 4.2.2 AirLeash Icons



| Icon | Meaning   |
|------|---|
|      | <b>Joystick mode.</b> When you enter this mode, you will be able to reposition AirDog farther or closer to you. |
|      | <b>Settings.</b> Enter Settings menu to set the various features of AirDog.                                     |
|      | <b>Pairing.</b> Enable to pair AirLeash with AirDog.  |

# 4. General Overview

---

| Icon  | Meaning   |
|---|---|
|    | <b>Sensor check.</b> Verify if AirDog and AirLeash sensors are ok to fly.   |
|    | <b>Calibration.</b> Enter calibration menu.   |
|    | <b>AirLeash calibration.</b> Enter AirLeash sensor calibration menu.  |
|    | <b>AirDog calibration.</b> Enter AirDog sensor calibration menu.  |
|    | <b>Magnetometer calibration.</b> This icon is used for AirDog and AirLeash magnetometer calibration.              |
|    | <b>Accelerometer calibration.</b> This icon is used for AirDog and AirLeash accelerometer calibration.            |
|    | <b>Gyro calibration.</b> This icon is used for AirDog and AirLeash gyro calibration.                              |
|    | <b>Factory Reset.</b> Reset AirLeash to factory settings. You need to update the latest firmware after the reset. |
|    | <b>Sports.</b> Enter Sport Flight Mode menu.  |
|  | <b>Surf</b>   |
|  | <b>Skatepark</b>  |
|  | <b>MTB - Mountainbike</b>   |
|  | <b>Wake Line</b>  |
|  | <b>Windsurf</b>   |





| Icon  | Meaning                       |
|---|-------------------------------|
|  | Backcountry Ski and Snowboard |
|  | Custom                        |

- ⓘ · Some icons may not yet be active.
- ⓘ · New icons might be available with software updates.

### 4.2.3 AirLeash Buttons









You don't need to spend much time getting your AirDog ready for flight. AirLeash only takes a few moments to either select a sport flight mode or to customize your settings.

“SP” - short press; “LP” - long press (3 sec.)

| Button  | On ground   | In flight  |
|---|---|--|
|    | LP (3sec.): Power AirLeash on/off<br>SP: Select/Confirm<br>LP (20sec.): Hard shutdown | LP (3sec.): Power AirLeash on/off<br>SP: Stop repositioning<br>LP (20sec.): Hard shutdown  |
|  | SP: Enter menu / Back in menu<br>LP: back to main                                     | SP: Enter / exit Joystick mode   |
|  | SP: Change value for flight parameter   | SP: Increase altitude by one step / Move farther away (while in Joystick mode)<br>LP: Continuously adjust the position: Altitude or Distance |

# 4. General Overview

---

| Button  | On ground                             | In flight  |
|---|---------------------------------------|--|
|    | SP: Change value for flight parameter | SP: Decrease altitude by one step / Move closer (while in Joystick mode)<br>LP: Continuously adjust the position: Altitude or Distance                                     |
|    | SP: Move Left while in menu           | SP: Orbit Left by one step<br>LP: Continuously orbit around you until  button is pressed  |
|    | SP: Move Right while in menu          | SP: Orbit Right by one step<br>LP: Continuously orbit around you until  button is pressed |
|    | SP: Initiate takeoff                  | SP: Start / Stop follow mode and pause Landing   |
|   | Inactive                              | SP: Initiates "Come to Me" command   |
|  | Inactive                              | SP: Initiates land on "SPOT" command<br>LP: Initiates "Return to Home" command   |
|  | Inactive                              | Inactive   |

## 4.2.4 AirLeash LEDs

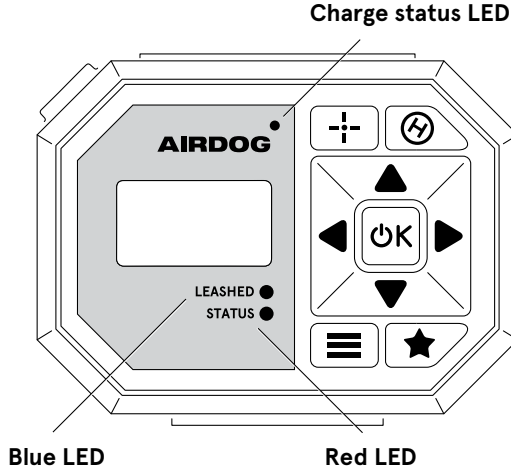

### Charge status LED

| LED Status   | Meaning                   |
|--------------|---------------------------|
| Solid yellow | AirLeash is charging      |
| Solid green  | AirLeash is fully charged |

### Blue "Leashed" LED

| LED Status  | Meaning                             |
|-------------|-------------------------------------|
| Off         | AirLeash is not connected to AirDog |
| Solid blue  | AirLeash is connected to AirDog     |
| Blinks blue | AirLeash is in pairing mode         |

### Red LED

| LED Status | Meaning                                 |
|------------|---|
| Off        | Everything is ok                        |
| Solid red  | System is faulty, check info on the LCD |
| Blinks red | AirDog battery is running low           |

## 4. General Overview

---

### 4.2.5 AirLeash Strap

The neoprene strap can be adjusted around the wrist or arm with a security slide to keep AirLeash firmly in place while in use.

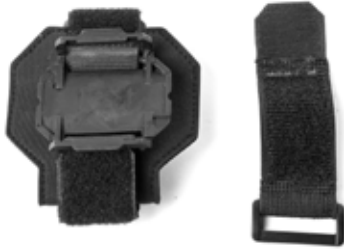

For best following performance, use the extender and AirLeash on the upper arm.

## 4.3 Battery Overview

AirDog's interchangeable 14.8 V, 5600mAh, lithium polymer battery provides an estimated flight time of 10-18 min. depending on flight speed and wind conditions. It must only be charged with an original AirDog battery charger.

We recommend purchasing multiple batteries to extend the flight time and use of AirDog during your action.

### 4.3.1 Level Indicator

The AirDog battery level Indicator shows how much power remains in the battery. To check the battery level, press the button below the LED indicators. The battery level indicators will light up to display the current battery level (see the picture on page 20).



AirDog’s battery level indicator has 5 LEDs that show how much power is remaining. To check battery charge level, press battery button for a short time while it is not inserted to any equipment. After short calculations, battery will show its charge. See below for details.

| LEDs status | Level     | LEDs status | Level    |
|-------------|-----------|-------------|----------|
| ● ● ● ● ●   | 90 - 100% | ● ● ● ● ●   | 40 - 50% |
| ● ● ● ● ●   | 80 - 90%  | ● ● ● ● ●   | 30 - 40% |
| ● ● ● ● ●   | 70 - 80%  | ● ● ● ● ●   | 20 - 30% |
| ● ● ● ● ●   | 60 - 70%  | ● ● ● ● ●   | 10 - 20% |
| ● ● ● ● ●   | 50 - 60%  | ● ● ● ● ●   | 0 - 10%  |

● – solid    ● – blinking    ○ – empty



We do not recommend using AirDog when the battery shows three or less solid LEDs.

# 4. General Overview

---

## 4.3.2 Battery Operation Modes

The AirDog smart battery features 3 different operation modes: Normal Mode, Sleep Mode, Safe Mode.

**Normal Mode** – In this mode, all functionality is enabled.

**Sleep Mode** – In this mode, powering AirDog or charging the battery is not possible. The battery enters into Sleep Mode after 30 minutes of inactivity. To switch the battery back to Normal Mode, remove it from the unfolded AirDog or from the charger and then insert it back.

**Safe Mode** – In this mode the battery is not operational and needs a firmware update. If the battery is connected to the charger, the level indicator will show the current battery level (see 4.3.1 Level Indicator).

If the battery is inserted into the unfolded AirDog, its firmware will be automatically updated, and once completed the battery will automatically switch to Normal Mode.

## 4.3.3 Firmware Update

The system will automatically check if the battery firmware needs an update every time the battery is inserted into the unfolded AirDog.

At the time of updating, AirLeash will display a message. Follow the steps as described on the AirLeash display until the update is completed (update process can take up to 1 minute).

In some very rare occasions the battery firmware starts normally, but it cannot communicate with AirDog. As a consequence, it is not possible to fly AirDog or update the battery firmware. In this case the battery must be manually switched to Safe Mode:

1. Remove the battery from the unfolded AirDog or from the charger adapter,
2. Long press (>12 sec.) the battery button below the LED indicators until you hear a tone and the LEDs start blinking,
3. Quickly release the battery button (don't wait more than 3 sec. after you hear a tone). The battery will switch automatically to Safe Mode and the LEDs will display the current battery status (see 4.3.4 Error And Status Codes),
4. Insert the battery into the unfolded AirDog. AirDog will now update the battery firmware automatically.



---

Removing the battery or folding the AirDog arms during the update firmware may cause a firmware damage.

### 4.3.4 Error And Status Codes

Errors are indicated by fast specific LED blink codes and tones. Errors will be only displayed for a limited time before the battery switches automatically to Sleep Mode. You can interrupt or repeat the error code at any time by short pressing the battery button below the LED indicators.

#### Common error codes:





The battery is too cold or too hot.  
Charging the battery, or using it is not possible.

# 4. General Overview

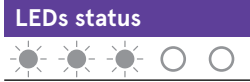
---





 – blinking     – empty

The battery is damaged, stop using it. The storage of this battery could be dangerous. Recycle the battery (see 5.2.5 Battery Disposal) or contact your AirDog representative.

Other error codes usually mean hardware/firmware problems.

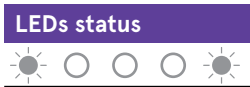
### Common status:



 – blinking     – empty

Battery is in Safe Mode while the firmware is being updated. This status is also displayed if the battery inserted into the unfolded AirDog or connected to the charger was previously switched to Safe Mode.

### 4.3.5 Battery Recovery Process

Follow the steps detailed below if the LED indicators on the battery display an error code and you are unsure what the problem is or if there seems to be an issue with the battery which behaves strange.

1. Use AirLoader to check that you have the latest firmware installed on your AirDog and AirLeash. Run the updates if necessary.
2. Insert the battery into the unfolded AirDog.



3. Power AirLeash on.
4. Wait until AirDog is paired with AirLeash or go through the pairing process.
5. Follow the steps on the AirLeash display. Sometimes this process will reset the battery even if AirLeash does not display any message.

In case the process fails and the battery cannot power AirDog anymore, contact your AirDog representative.

### 4.3.6 Battery Charger And AC Wall Plug Adapters

The battery charger is designed for AirDog's battery only. One power cord (US) and one power adapter (EU) are included in the AirDog packaging.



# 4. General Overview

## 4.4 Mobile App Overview

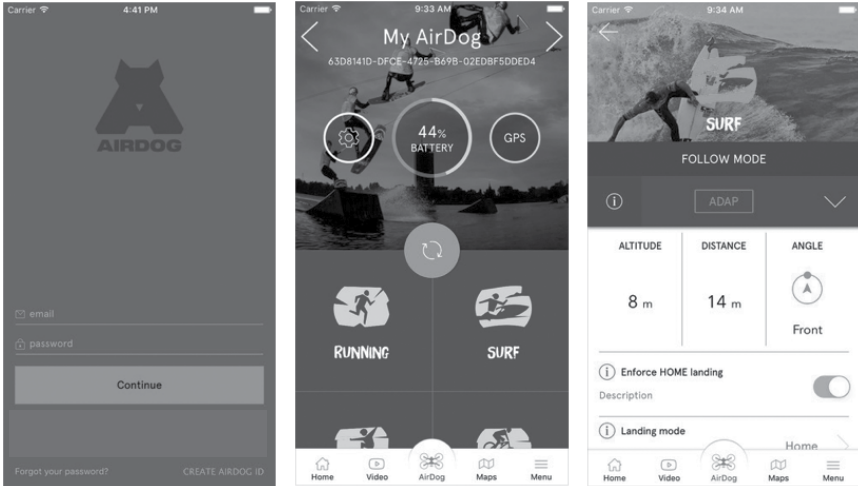

The AirDog mobile app enables the user to register and activate AirDog.

Use the AirDog app to adjust, customize and fine-tune sport mode settings. You can also customize sport mode settings directly via the AirLeash.

With any customization of the sport flight mode settings, always synchronise the app with AirDog. AirDog is controlled by AirLeash only, the AirDog mobile app is for customizing settings through the ease of your smart device only.



- The AirDog app does not let you select a sport and control AirDog. The app lets you customize the settings only.
- When customizing a sport flight mode, always chose a sport that reflects the sport you are going to carry out.
- Do not select or customize the settings of a preset sport which does not correspond to the sport you are effectively performing.

- In the “Custom” Sport icon of the AirDog app, always make certain that you don’t select Land On Spot as a landing mode and Follow terrain if you are going to practice a sport on the water (AirDog is not intended to land on water and doing so may irremediably cause serious damage or the loss of AirDog).

## 4.5 AirLoader Desktop App Overview

The AirLoader desktop app enables the user to update the latest firmware for AirDog and AirLeash.

The AirLoader desktop app is also used to download log files from AirDog and AirLeash and upload them to the AirCloud. It is also used to report problems to our support team.

You can download and update the AirLoader desktop App here:  
<https://www.airdog.com/support>

## 4.6 Sport Modes

There are several sport modes that you can select with AirLeash. Each sport mode consists of a Follow mode, Landing mode and sport-specific flight parameters. Flight parameters in each sport mode can be customized for better user experience.

We recommend you first get acquainted with the preset Sport Modes before you customize your own sport.

AirDog will add new sports and flight parameters through software and app updates.

# 4. General Overview

---



- Before customizing the settings of a sport always select a sport which corresponds to the sport that you are effectively performing.
- Do not select a sport or customize the settings of a sport which does not correspond to the sport you are to carry out.
- In the Custom Sport icon, always verify that you don't select Land On SPOT as a landing mode and Follow terrain if you are going to practice a sport on the water.

## 4.6.1 Sport Mode Descriptions

### MTB (Mountainbike)



Want to capture your mountain bike run? Just take AirDog out of your backpack unfold it, put on the propellers and take it up in the air. Set the angle, push Play button and go! In the FIXED follow mode AirDog will maintain the angle that you have set, for example South from you, and descend and ascend depending on your track.

---

|                  |                                  |
|------------------|----------------------------------|
| Follow mode:     | <b>FIXED (default), ADAPTIVE</b> |
| Altitude:        | <b>10 meters / 33 feet</b>       |
| Follow distance: | <b>13 meters / 43 feet</b>       |
| Follow terrain:  | <b>ON</b>                        |
| Landing mode:    | <b>SPOT</b>                      |

---

### Backcountry



Head up to that beautiful spot you scoped out, unpack AirDog, send it up and push Play button. Set the position in which you want AirDog to follow and start to descend. Remember to make necessary adjustments on AirLeash if there are trees in your path.

---

|                  |                                  |
|------------------|----------------------------------|
| Follow mode:     | <b>ADAPTIVE (default), FIXED</b> |
| Altitude:        | <b>8 meters / 25 feet</b>        |
| Follow distance: | <b>12 meters / 40 feet</b>       |
| Follow terrain:  | <b>ON</b>                        |
| Landing mode:    | <b>SPOT</b>                      |

---

## Windsurf



If the wind is not stronger than 28 knots (14 meters per second) AirDog will help you capture your windsurfing, sailing or kitesurfing action. Just find a safe takeoff/landing (HOME) zone on the beach, initiate takeoff, grab your board and ride.

---

Follow mode: **FIXED (default)**

---

Altitude: **13 meters / 43 feet**

---

Follow distance: **18 meters / 60 feet**

---

Follow terrain: **OFF**

---

Landing mode: **HOME**

---

## Wake Line



If you are riding in straight line cable parks AirDog will stay safe and away from the cables. So all you need to do is to set two endpoints in the map of desired flight path (typically parallel to the cable) using the AirDog mobile app. In a few seconds you will be ready to shred your favorite slides and kickers with AirDog following on the side, keeping itself on the marked line and out of the water and away from the cable lines.

---

Follow mode: **LINE (default)**

---

Altitude: **8 meters / 26 feet**

---

Follow distance: **(not used)**

---

Follow terrain: **OFF**

---

Landing mode: **HOME**

---

## Skatepark



This mode is perfect for skateparks and areas with obstacles like trees or lightning poles. AirDog will follow you with the camera, but will stay hovering in a fixed position. You will be able to reposition AirDog via "Joystick mode".

---

Follow mode: **HOVER**

---

Altitude: **7 meters / 23 feet**

---

Follow distance: **(not used)**

---

Follow terrain: **OFF**

---

Landing mode: **HOME**

---

# 4. General Overview

---

## Surf



When the surf's up, just unfold AirDog, set a timer (the amount of time you need to get to the break), set the distance to the break, point AirDog (with the camera) in the direction you'll paddle out to, and leave it in a safe takeoff/landing (HOME) spot, grab your board, paddle in.

After the timer runs out AirDog will take off and fly to your position, wait until you catch the wave and film you from the front. With the press of a button or when the battery runs low AirDog automatically flies back to the HOME location.

---

Follow mode: **ADAPTIVE (default), FIXED**

---

Altitude: **8 meters / 25 feet**

---

Follow distance: **13 meters / 42 feet**

---

Follow terrain: **OFF**

---

Landing mode: **HOME**

---

## Custom sport

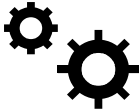

For advanced users! If you feel comfortable with the preset sports and the customization of their respective settings you can explore new angles and improve your video footage with Custom mode. It enables you to customize each setting and get more creative with AirDog.

---

Follow mode: **FIXED, LINE, ADAPTIVE (default), CIRCLE AROUND**

---

Altitude: **10 meters / 33 feet**

---

Follow distance: **10 meters / 33 feet**

---

Follow terrain: **ON or OFF**

---

Landing mode: **HOME (default), SPOT**

---



The AirDog limited warranty is void when there is a damage caused by the drone or the loss of the drone resulting from the use of the Custom mode which does not respect the following restrictions:

- Ensure that the use of AirDog is authorized in your flight area and at a safe distance of at least 80 feet (25 meters) away from any infrastructure and individuals.
- At least 120 degrees of clear sky at all times to produce the highest quality of GPS and avoid unpredictable behaviour with the drone when GPS signal is lost.
- No flights above water.

## 4.6.2 Follow Modes

Follow modes enable AirDog to follow you while maintaining the position and altitude that you have set, allowing AirDog to track you with the camera as you move.

**FIXED** → Fixed follow

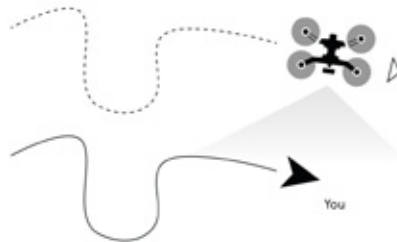

In this mode AirDog stays at a fixed distance, altitude and angle from you regardless of your directional movement. In simpler terms, it will always stay to the north, south, west or any other angle that is set. This mode is used for sports where you have a wide open space and there are no obstacles to avoid, such as surfing or when flying at an altitude high above any potential obstacles.

# 4. General Overview

---

## HOVER → Hover & aim

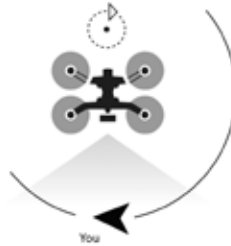

This is the simplest filming mode in which you can position AirDog at a fixed position and altitude and it will simply pan around and adjust camera pitch to keep you in frame. This was developed for tight places such as smaller skate parks with trees around or race tracks where you want to film a much faster moving car or bike than AirDog can actually fly. While in this mode the arrow buttons on AirLeash act as a remote control joystick to make AirDog positioning simple.

## LINE → Follow line

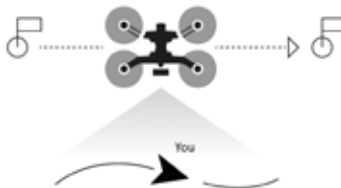

If you love cable wakeboarding then this mode will make filming in a straight line cable park safe and simple. Place 2 endpoints of the flight path along the cable using the map in the AirDog mobile app and you're ready to film and shred all day long. This mode can be used in many creative ways, just imagine what cinematographic effects you can achieve limiting AirDog's movement along a straight line but being able to move around freely.



## ADAP → Adaptive follow

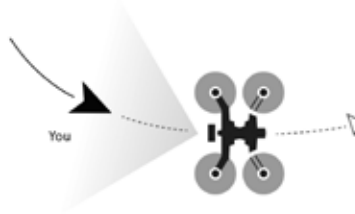

In this spectacular mode AirDog will travel relative to your movement. You can set it to stay at any angle relative to your direction, for example in front of you and it will do its best to make sure your smile is captured. If you suddenly switch directions, AirDog will fly around you to reposition itself to the front. This will result in a smooth panoramic footage. If you stop while AirDog is repositioning it will stop too. You can set AirDog to stay behind you and it will result in a chasing behaviour, AirDog will try to repeat your path and trajectory.

## CIRC → Circle around

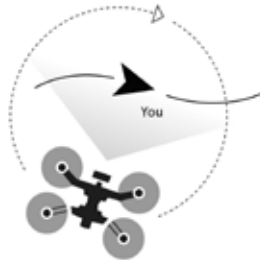

In this mode AirDog rotates around you continuously even if you are moving. In simpler terms, it will always fly around you and follow you. This mode is used for sports where you have a wide open space and there are no obstacles to avoid. This mode is used to capture your surroundings with a smooth panoramic footage.

# 4. General Overview

---

## 4.6.3 Landing Modes

Landing is completely autonomous, allowing you to focus on your action. AirDog will land at the end of your run in close proximity to you, or return to the takeoff spot. Landing modes will be automatically initiated by AirDog when low battery level is reached or by the user manually sending a command from AirLeash.

**HOME** → Return To Home

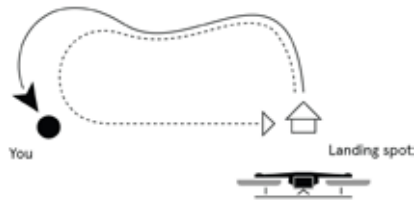

In this landing mode AirDog will ascend to the preset Return To Home at safe altitude and then fly in a straight line to the initial takeoff or home location and land. The default Return To Home altitude is 65 feet (20 meters), but it can be adjusted via AirLeash. This is very useful for flat sports and water sports such as surfing.

You can initiate the Return To Home landing mode manually by long pressing (4sec.) the  button on AirLeash.

**HOME landing will be initiated automatically when low battery level (approx. 30%) is reached.**

## SPOT → Land On Spot

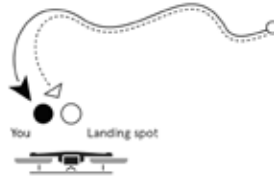

In this landing mode AirDog will perform landing at its current position. Typically this is used in downhill sports such as snowboarding or skiing where you want to land AirDog at your chosen spot in the line of sight not far away from you when you're done with your ride or when the battery is low.

You can initiate the Land On Spot landing mode manually by short pressing the  button on AirLeash.

**Land On SPOT landing mode will be initiated automatically when critical battery level (approx. 20%) is reached.**

\* SPOT landing may be performed also if AirDog detects technical failure.



In the "Custom" sport icon of AirDog app, always verify that you don't select **Land On Spot** as a landing mode if you are going to practice a sport on the water.

# 5. System Preparation

---

Understand everything that needs to be done with the system before flight.

## 5.1 AirDog

### 5.1.1 Unfolding The Arms

The arms on AirDog are designed to fold in tightly. This makes it easy to store in a small case or backpack.

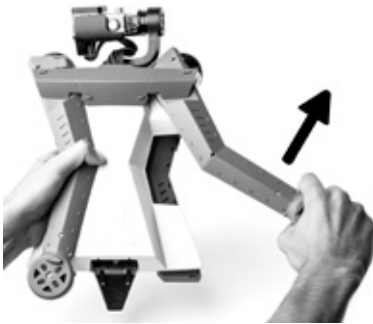

**To unfold the front arms push/pull them until a snap is heard:**

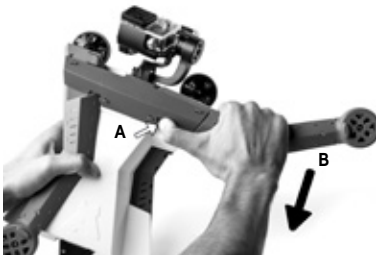

**To fold the arms back together:**

1. Carefully press the small release button.
2. Slowly fold the arm back to AirDog's body

- ⓘ · Be careful while folding the arms as there is a risk of pinching your fingers when you press the small release button with your thumb.
- Ensure the arms are unfolded correctly until a click is heard and in good condition before each flight.
- Do not try to unfold or fold the arms while the propellers are rotating and always turn off AirDog before handling the arms.
- AirDog won't power up if the arms are in a folded position.

## 5.1.2 Attaching The Landing Gears



### Unfold the front landing gear:

1. Take the "Y" shaped part and lift it up.
2. Take the support part and lift it up so the hook snaps in place.



### Unfold the landing gear for both rear arms:

1. Tilt the landing gear up.
2. Press with your thumb, to lock the landing gear in place.

# 5. System Preparation

---

## 5.1.3 Attaching The Propellers

Due to AirDog's foldable arms, there are four different propellers. Two of them are for the front arms (motors face down) and two are for the rear arms (motors face up). Before attaching the propellers turn them face up so you can see the padlock symbol:



Place AirDog in front of you with the arms unfolded.

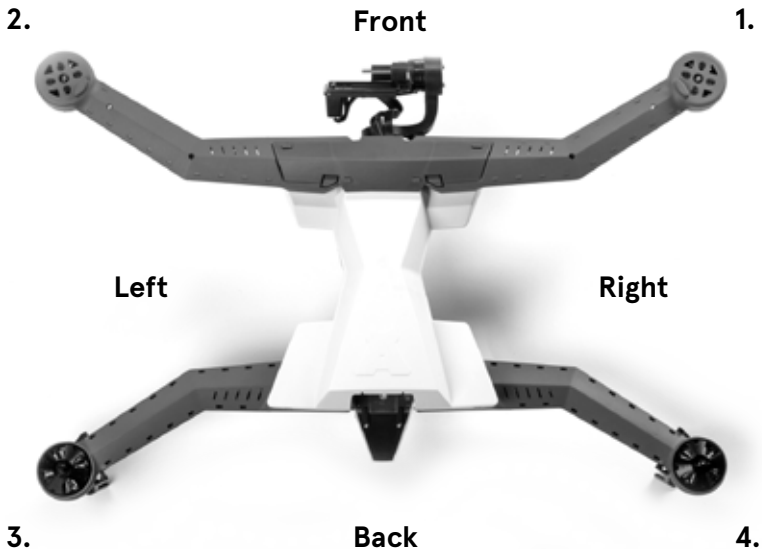

Propeller 1: Front Right arm (1.)

- Padlock facing up
- Black nut with white stripes facing down

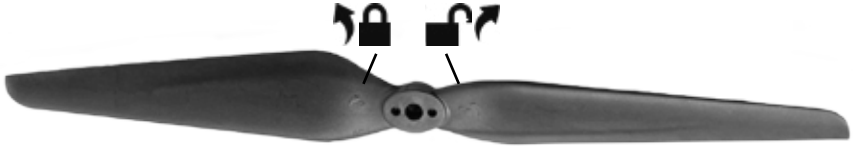

Propeller 2: Front Left (2.)

- Padlock facing up
- Black nut facing down

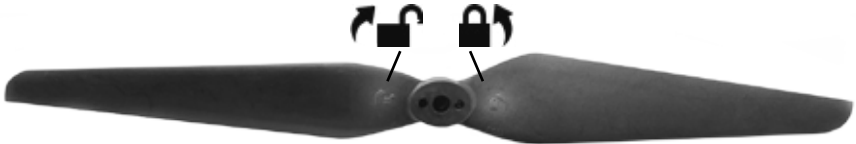

Propeller 3: Back Left (3.)

- Padlock facing up
- Black nut facing up



Propeller 4: Back Right (4.)

- Padlock facing up
- Black nut with white stripes facing up

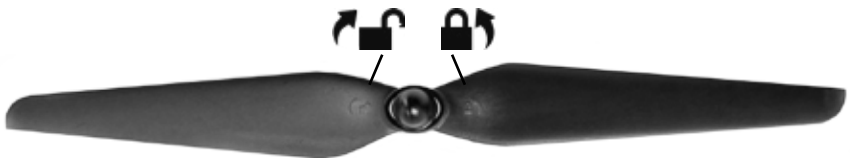

# 5. System Preparation

---

Tighten the propellers according to arrows next to padlock icons:



Lock - Turn the propellers in the indicated direction to mount and tighten.



Unlock - Turn the propellers in the indicated direction to loosen and remove.



- Always ensure the propellers are attached correctly and in good condition before each flight.
- AirDog's propellers self-tighten during the flight. Don't over-tighten the propellers or use excessive force – this risks damaging the threads in the hubs.
- Always use original AirDog propellers.
- Rotating propellers may cause injury to persons, animals or property. Do not touch AirDog when the propellers are rotating and always turn off AirDog before handling AirDog or the propellers.
- Ensure that rotating propellers are always at least 10 feet (3 meters) away from any person, animal or property before operating AirDog.

## 5.1.4 Recommended GoPro Settings

Here are our suggested GoPro HERO 3/3+/4 camera settings:

- FOV (field of view): MEDIUM
- Resolution: Full HD 1080 or 2.7 K
- Frame rate: 50 or 60 fps
- Wifi: OFF

The rest of the settings can be set to your preference.



## 5.1.5 Mounting The Camera

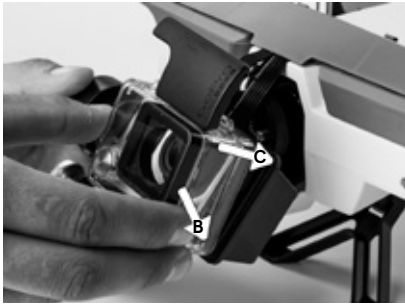

1. Gently place the action camera so it fits the camera connector securely.
2. Take the action camera housing and position the bottom part first.
3. Push the camera housing's top so it fits over the camera.
4. Secure the action camera housing's top by pressing down on the housing's lever.
5. Secure the action camera housing's bottom by tightening the security screw on the bottom.

# 5. System Preparation

---

- ⚠️ • Always ensure the camera is mounted and connected correctly before each flight.
- Never try to mount or unmount the camera while the propellers are rotating.
- Always turn off AirDog before handling the camera.

## 5.1.6 Inserting The Battery



**To insert the battery** into the battery compartment turn the battery face up (so you see AirDog logo) and slide it in until a snap is heard.



**To remove the battery:**

1. Press and hold the release button.
2. Pull the battery outside.

- ⚠️ • Ensure the battery is inserted correctly until a snap is heard and in good condition before each flight.
- AirDog will only power if all of the arms are unfolded properly.

## 5.2 Battery

### 5.2.1 Charging The Battery

AirDog's battery ships with approximately 30% charge, the battery must be fully charged before each flight. AirDog's battery is a lithium polymer battery. Lithium Polymer batteries don't have memory and the battery does not need periodic full discharge cycles to prolong life.



#### To charge the battery:

- A. Manually connect the yellow wire to the adapter and the charger. If you don't do that the batteries will not charge.
- B. Connect the battery to the battery charger provided.
- C. Plug the battery charger into a wall socket (100–240V, 50/60Hz) with the appropriate adapter.

Once the battery is connected to the powered charger, the LED indicators on the battery will display the "connected" status code and the battery will emit a beep:



While it is charging, the LED indicators will display the current battery level (see 4.3.1 Level Indicator).

The battery is designed to charge when the temperature range is between 41°F (5°C) and 104°F (40°C). The battery will stop charging when these temperature levels are exceeded and the LED indicators will display an error code (see 4.3.4 Error And Status Codes). The battery will resume charging once the operating temperature is within the limits and after you've disconnected then connected again the battery to the powered charger.

# 5. System Preparation

---

The battery will automatically switch to Sleep Mode if it is connected to an unpowered charger for more than 30 minutes. The battery will resume charging after you've disconnected then connected it again to the powered charger.

If a damaged battery is connected to the powered charger, the LED indicators will display an error code (see 4.3.4 Error And Status Codes) and the charging process will not start.

Pressing the battery button while the battery is charging provides status codes used for service purposes only.

Normal charging time should take 3 hours and AirDog's battery is rechargeable for over 100 full cycles. A full cycle is when AirDog's battery is charged from 0% to 100%. After 100 cycles, AirDog's battery may provide less than 80% of its original capacity.

- 
- ⚠ • The red banana jack connects into the red terminal on the battery charger and the black banana jack connects into the black terminal on the battery charger. Do not reverse banana jacks and battery charger terminals at anytime.
  - Fully charge the battery before each flight.

## 5.2.2 General Guidelines And Warnings

- ⚠ • Never charge the battery unattended. Always charge the battery on a non-flammable surface such as concrete and away from any flammable materials.
- Lithium Polymer batteries are volatile. Failure to read, understand and follow the below instructions may result in fire, personal injury and damage to property if charged or used improperly.
- Always use original AirDog batteries and battery chargers. Failure to do so may cause a fire, which may result in personal injury and property damage.
- Do not disassemble, pierce, distort or cut the battery or the battery charger. It may result in a risk of electric shock or fire.

- Do not use the battery if it has received a sharp blow, been dropped or otherwise damaged in any way. Never use again a battery which has fallen into water.
- If at any time you witness a battery starting to balloon or swell up, discontinue charging process immediately. Disconnect the battery, place it in a safe area outside of any building or vehicle and away from any combustible material and do not use it. Continuing to charge a battery that has begun to swell will result in fire.
- Never expose, store or charge the battery in extreme temperatures, since extreme temperature could cause fire.
- Stop using the battery if you notice it is draining faster than normal.
- Do not operate the battery charger with a damaged cord or plug.
- Do not operate the battery charger if it has received a sharp blow, been dropped or otherwise damaged in any way.

### 5.2.3 Before Using The Battery

- ⚠ · Make a visual inspection of the battery before and after each flight. Look for any damaged leads, connectors, broken shrink-wrap, swelling of cells, or other irregularities.
- Do not use if you find any of the above issues with your battery.

### 5.2.4 Storage And Transportation

The battery should be partially charged during storage and the optimal storage charge for the battery is 40-60% (which is three out of five LEDs on the battery level indicator). Storing battery at a depleted charge under 20% (one LED on the battery level indicator) for a longer period of time may result in a shortened battery life or permanent damage to the battery.

- 
- ⚠ · Store the battery at room temperature between 40°F and 80°F (4°C and 26°C) for best results, relative humidity approximately 50%.
  - Do not expose the battery to direct sunlight (heat) for extended periods.
  - Keep the battery out of the reach of children.
  - Remove the battery from AirDog when you are not using it.
  - Always pack your LiPo batteries in your carry-on bag and never in your checked baggage when traveling on an airplane.

# 5. System Preparation

---

## 5.2.5 Battery Disposal

- ⚠ • Batteries that lose 20% of their capacity must be removed from service.
- Before recycling, discharge the battery, make sure output wires are correctly insulated, and then wrap the battery in a bag.
- Do not dispose of the battery in the trash! Take your battery to an approved battery recycling facility. In the US, visit [call2recycle.org](http://call2recycle.org) for a location near you or for further information contact your local solid waste authority.

## 5.3 AirLeash

### 5.3.1 Charging AirLeash

The included micro-USB cable allows you to charge your AirLeash (USB, US and Euro wall adapters included). Connect the supplied micro USB cable to your computer or any power source with a USB out, like the USB wall adapter included with your AirLeash.



- 
- ⚠ • The AirLeash battery must be fully charged before each flight.
  - Ensure that the micro USB cover is closed tightly to prevent water and dust entering AirLeash. Open or loose the cover may allow water and dust to enter AirLeash and cause damage.

### 5.3.2 Pair With AirDog















The easiest way to check if your AirDog is paired with AirLeash is to turn them both on and then wait (about 30sec.) and look at the “Leashed” Blue LED on AirLeash. If it lights up solid blue, you are good to go, if not you need to pair your devices.

If you see the message: “Not paired press OK to pair” on AirLeash then continue reading the instructions below, starting from step 5.

#### **AirLeash is not paired with AirDog before delivery.**

If you don’t see the message “Not paired press OK to pair” and the “Leashed” LED doesn’t light up a solid blue, then follow these steps:

1. Turn on AirLeash by long pressing (3sec.) the (Power/OK) button .
2. Short press Menu button  on AirLeash, navigate through Menu with arrows   until you see the Settings icon  on the LCD screen.
3. Short press on  (Power/OK) to enter Settings .
4. Navigate through the Settings with arrows   until you see Pairing icon  on the LCD screen.
5. Short press on  (Power/OK) button and a warning message: “Are you sure?” will pop up, short press on  (Power/OK) button to proceed and the pairing process will start. On your AirLeash LCD screen you will see a message “Pairing, Long press pairing button on AirDog”.
6. Turn on your AirDog (unfold all arms and insert the battery).
7. Long press (3sec.) “tail button” until you hear a long beep to switch Pairing Mode on. AirDog’s all LEDs will begin flashing when it is in Pairing Mode (Pairing process can take up to 2 minutes).



# 5. System Preparation

---

8. When you see the message "Pairing done, now it is safe to turn off pairing on AirDog", your AirLeash is paired to your AirDog. If you have another AirLeash that you want to pair to this AirDog, then repeat steps 1-5 without exiting the Pairing mode (pairing another AirLeash will be available with software updates).
9. After you have successfully paired your AirLeash with AirDog, long press (3sec.) the "tail button" until you hear a long beep to switch Pairing Mode off. AirDog LEDs will stop flashing after 20sec. and you will see the "Leashed" LED light up in solid blue and you will be able to see AirDog's battery level etc.

## 5.3.3 Strapping AirLeash

One of the advantages of AirLeash is that it is just like wearing a watch, leaving full use of both hands while performing your favorite outdoor sport. AirLeash is securely strapped around your wrist, enabling you to easily access the control buttons even with gloves or wet hands. AirLeash is waterproof and submersible.

**Follow these instructions to strap AirLeash around your wrist:**



Step 1



Step 2





Step 3



For best follow results use the AirLeash extender and attach AirLeash on the upper arm.

- 
- ⚠ • Ensure AirLeash is strapped correctly and firmly around the wrist or the upper arm.
  - Do not disassemble or open AirLeash. It will no longer be waterproof if it is opened. Opening AirLeash may cause damage that is not covered by the limited warranty.
  - Switch off all other Bluetooth devices within range or disable their Bluetooth functionality such as wireless headphones or fitness trackers.
  - Do not place AirLeash in a pocket or cover it with a sleeve. It should always be visible and not hidden behind a layer. Failure to do so may lower the wireless signal and there is a risk you may crash AirDog.

## 5.4 AirDog Mobile App

### 5.4.1 Download And Install AirDog App

1. Download the AirDog mobile app from the Apple App store or Google Play store.
2. Install the AirDog mobile app on your smartphone / smart device.

# 5. System Preparation

---

## 5.4.2 Activation Of AirDog

1. Open the AirDog app on your smart device and create a new AirDog ID or login with an existing account.
2. Unfold all AirDog arms and insert the battery to turn your AirDog on.
3. Switch on pairing mode on by long press (3sec.) "tail button" until you hear a long beep and AirDog's LED's start flickering.
4. In the app, press the "Search" button and the app will find your AirDog.
5. Then press the "Connect" button in the app to connect to your AirDog.
6. When the app has connected to AirDog for the first time it will display the "Activate" button. Press it and your AirDog will be registered to your account and activated\*.

---

\*Please note that AirDog must be registered and activated before use.

## 5.4.3 How To Customize A Sport Mode Via AirDog Mobile App

Example: customization of a sport mode\*

- Turn on AirDog by unfolding the arms and inserting the battery.
- Start the AirDog mobile app and log in to your account and tap "search".
- The app will find your AirDog and you will have to press "connect" button.
- After you are connected to the AirDog you can start customizing your desired sport mode:



**Follow mode:** choose from available Follow modes

**Distance:** customize distance between the user and AirDog

**Altitude:** customize takeoff and follow altitude

**Enforce home landing:** forces AirDog to land at HOME even if SPOT landing requested from AirLeash

**Landing mode:** choose from different landing modes

**Start follow after takeoff:** choose if you want AirDog to skip Hover & Aim mode and switch to follow immediately after takeoff

**Return to home altitude:** set safe altitude for AirDog to climb to before returning HOME

**Follow terrain:** enable to ensure that AirDog follows your altitude changes

## Advanced parameters

**Acceleration:** adjust how fast AirDog will reach your speed

**Reaction:** adjust how aggressively AirDog will control its movements while flying

---

\*Depending on the sport mode you have selected, you may not be able to select or modify some settings.

After you have customized all desired parameters press the back arrow  to return to the main screen:

# 5. System Preparation

---

Press the green circle in the middle of the screen to synchronize the parameters with AirDog. Once the arrows stop to spin you have successfully synced parameters from you mobile app to AirDog.



## 5.5 GPS

AirDog's positioning precision can be affected by variation in GPS accuracy over the duration of a flight. GPS position accuracy can be within 16 ft. (5 m) and we recommend you fly AirDog in an open corridor within 165 ft. (50m) where there are no obstructions for the satellite signals. Obstructions such as hills, tall buildings, and trees may block the satellite signal.

## 5.6 Calibration

AirDog and AirLeash do not require calibration before each flight even if you are moving to a new flight location.

Please note that all AirDog and AirLeash sensors have been factory-calibrated. Accelerometer and Gyroscope sensors should be recalibrated **ONLY** if AirLeash displays such warning message. Compass calibration shouldn't be done unless there is a physical sensor replacement or the AirLeash displays this warning message.

You don't need to remove AirDog's propellers when performing the calibration process. Ensure both systems are powered before you start the calibration process.

### 5.6.1 AirLeash Calibration

Please note that all AirLeash sensors have been factory-calibrated. Accelerometer and Gyroscope sensors should be recalibrated **ONLY** if AirLeash displays the calibration warning message.



















### 5.6.1.1 AirLeash Magnetometer (Mag) Calibration ◀

Calibrate magnetometer on AirLeash **ONLY** if you are notified that it is necessary.

The magnetometer is very sensitive to magnetic interferences and its calibration requires an interference-free environment. Stay away from metal and concrete structures such as buildings, parkings or any metal structures. Do not wear gloves or rings with magnets or other ferromagnetic metals while performing the calibration steps.

AirLeash is only meant to work outdoors and indoor calibration will lead to faulty measurements.

#### **Magnetometer calibration process:**

1. Long press (3sec.) on Power/OK button  to power AirLeash on.
2. Short press on Menu button  to enter Menu.
3. Navigate through Menu with arrows   until you see the Settings icon  on the LCD screen.
4. Short press on Power/OK  to enter Settings .
5. Navigate through Settings with arrows   until you see the Calibration icon  on the LCD screen.
6. Short press on Power/OK  to enter Calibration menu.
7. Navigate through Calibration menu with arrows   until you see the AirLeash Calibration icon .
8. Short press on Power/OK  to enter AirLeash Calibration menu.
9. You will see a message "Watch video: [help.airdog.com](http://help.airdog.com)", it is strongly advised to go and watch the calibration videos before you calibrate any sensors. Press Power/OK  and you will be forwarded to the next info screen where you can choose to either read more calibration tips (press Power/OK  button to see them) or you can skip the tips by pressing Play/Pause button .

# 5. System Preparation

---

10. Calibration will start after 5 sec., a message stating "Hold THIS side up" with an Arrow pointing to the side that you must hold up will appear:

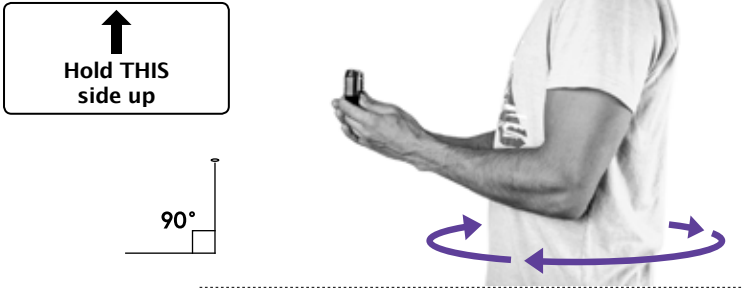

11. Hold AirLeash steady and at a 90° angle (relative to the ground level) until you see a message: "Rotate AirLeash 360 degrees", do not rotate until you see the message.

12. After a full rotation AirLeash will display the next message "Hold THIS side up", it will be upside down, so you have to rotate AirLeash so that the text is readable:

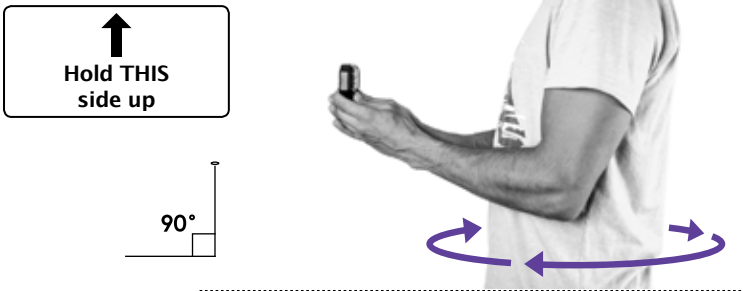

13. Hold AirLeash steady and at a 90° angle (relative to the ground level) until you see a message: "Rotate AirLeash 360 degrees" only then start rotating 360 degrees.

14. After a full rotation AirLeash will display the next message "Hold THIS side up", it will be upright at 90°, rotate AirLeash so that the text is readable:



15. Hold AirLeash steady and at a 90° angle (relative to the ground level) until you see a message: "Rotate AirLeash 360 degrees" only then start rotating 360 degrees.
16. After a full rotation AirLeash will display the next message "Hold THIS side up", it will be upside down, so you have to rotate AirLeash so that the text is readable:

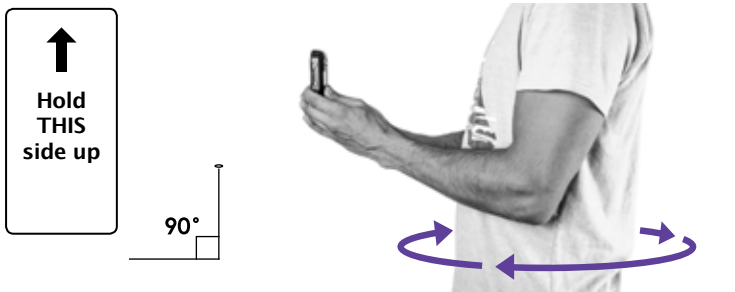

17. Hold AirLeash steady and at a 90° angle (relative to the ground level) until you see a message: "Rotate AirLeash 360 degrees" only then start rotating 360 degrees.
18. After a full rotation AirLeash will display the next message "Hold AirLeash display UP":

# 5. System Preparation

---

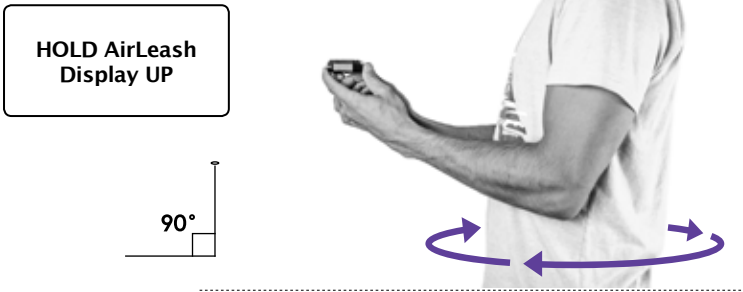

19. Hold AirLeash steady and at a 90° angle (relative to the ground level) until you see a message: "Rotate AirLeash 360 degrees" and hear the "calibrating" tone, only then start rotating 360 degrees.
20. After a full rotation AirLeash will display the next message "Hold AirLeash display DOWN":

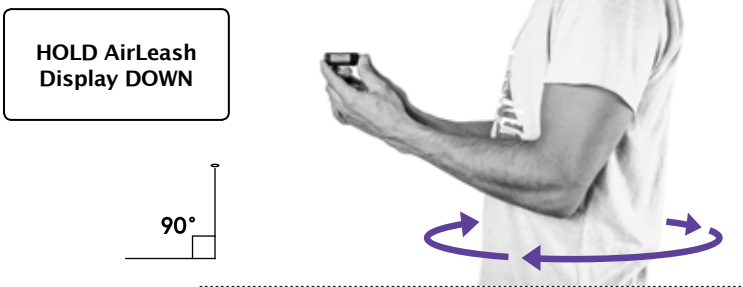

21. Hold AirLeash steady and at a 90° angle (relative to the ground level) until you hear the "calibrating" tone, only then start rotating 360 degrees.
22. Continue rotating until you'll hear a "success" tone and then turn AirLeash display UP so you see the message "Calibration COMPLETED Press OK" short press on Power/OK  to complete calibration process.
23. During calibration you may get two error messages:























- a. If you get “FAILED motion detected hold still or calibrate gyro” restart calibration again and hold AirLeash really steady in each position. If error message appears again calibrate AirLeash GYRO and then recalibrate AirLeash Magnetometer.
- b. If you get “FAILED wrong angle” restart calibration again and hold AirLeash at a 90° angle (respective to the ground level).”

### 5.6.1.2 AirLeash Accelerometer (Accels) Calibration >>>

Calibrate Accelerometer on AirLeash **ONLY** if you are notified that it is necessary.

Follow the figures as indicated below to complete accelerometer calibration. Make sure to hold AirLeash in each Axis position level and steady until it makes a sound and displays the message “Change side and hold still” before moving to the next position.

#### Accels calibration process:

1. Long press (3sec.) on Power/OK button  to power AirLeash on.
2. Short press on the Menu button  to enter Menu.
3. Navigate through the Menu with arrows   until you see the Settings icon  on the LCD screen.
4. Short press on Power/OK  to enter Settings .
5. Navigate through Settings with arrows   until you see the Calibration icon  on the LCD screen.
6. Short press on Power/OK  to enter Calibration menu.
7. Navigate through Calibration menu with arrows   until you see the AirLeash Calibration icon .
8. Short press on Power/OK  to enter AirLeash Calibration menu.
9. Navigate through the Calibration menu with arrows   until you see Accels icon  on the LCD screen.
10. When you see the message “Watch video: [help.airdog.com](http://help.airdog.com)”, it is strongly advised to watch the calibration videos before you calibrate any sensors. Press Power/OK  and you will be forwarded to the next info screen where you can choose to either read more calibration tips (press Power/OK button  to see them) or you can skip the tips by pressing the Play/Pause button.

# 5. System Preparation

---

11. Calibration will start after 5 sec., a message stating "Hold THIS side up" with an Arrow pointing to the side that you must hold up will appear:

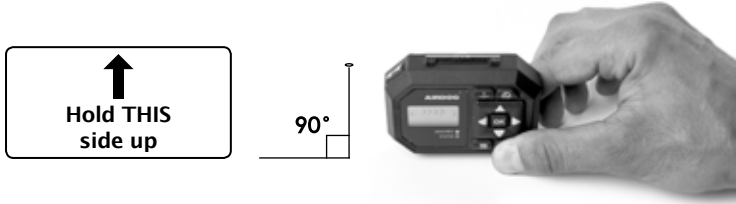

12. Hold AirLeash steady at a 90° angle (relative to the ground level) a message: "HOLD STILL" will appear, do not move while this message is visible.
13. When you hear a different tone and the message "HOLD STILL" changes to the next message "Hold THIS side up", rotate AirLeash so that the text is readable:

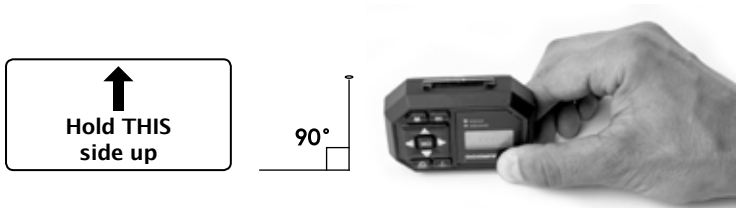

14. Hold AirLeash steady at a 90° angle (relative to the ground level) a message: "HOLD STILL" will appear, do not move while this message is visible.
15. When you hear a different tone and the message "HOLD STILL" changes to the next message "Hold THIS side up", rotate AirLeash so that the text is readable:

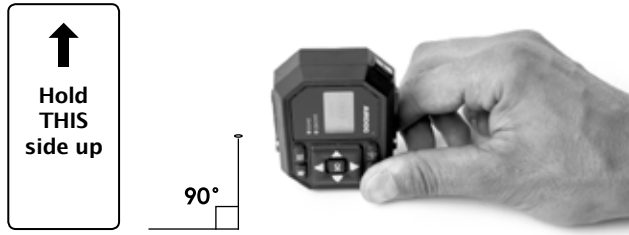

16. Hold AirLeash steady at a 90° angle (relative to the ground level) a message: "HOLD STILL" will appear, do not move while this message is visible.
17. When you hear a different tone and the message "HOLD STILL" changes to the next message "Hold THIS side up", rotate AirLeash so that the text is readable:

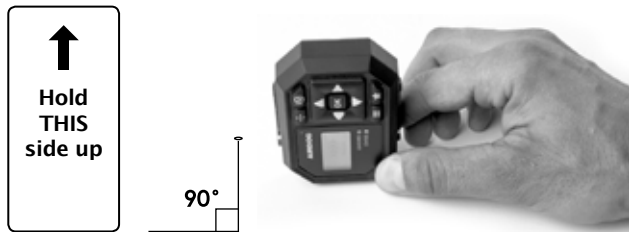

18. Hold AirLeash steady at a 90° angle (relative to the ground level) a message: "HOLD STILL" will appear, do not move while this message is visible.
19. When you hear a different tone and the message "HOLD STILL" changes to the next message "Hold AirLeash Display UP", place AirLeash on level surface:

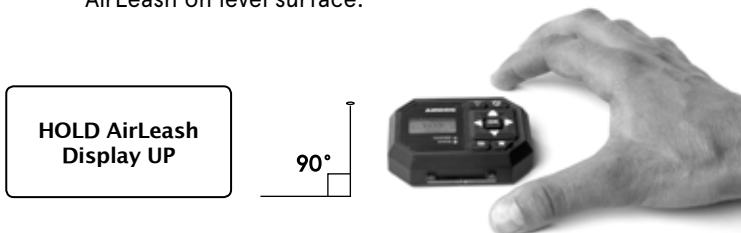

20. A message: "HOLD STILL" will appear, do not move while this message is visible.

# 5. System Preparation

---

21. When you hear a different tone and the message "HOLD STILL" changes to the next message "Hold AirLeash Display DOWN", place AirLeash on level surface display facing down:

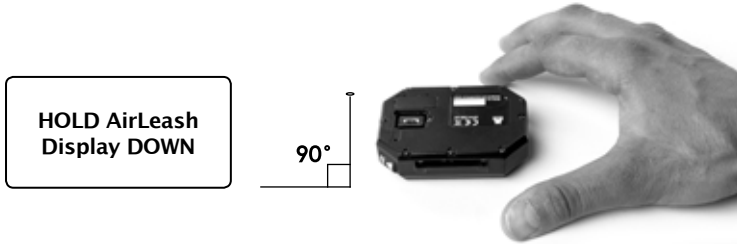





22. When you hear the "success" tone, turn the AirLeash display UP so you see the message "Calibration COMPLETED Press OK" short press on Power/OK to complete calibration process.
23. During calibration you may get two error messages:
  - a. If you get "FAILED motion detected recalibrate and hold still" restart calibration again and hold AirLeash really steady in each position.
  - b. If you get "FAILED wrong angle" restart calibration again and hold AirLeash at a 90° angle (respective to the ground level).













### 5.6.1.3 AirLeash Gyroscope (Gyro) Calibration

Calibrate Gyroscope on AirLeash **ONLY** if you are notified that it is necessary.





Follow the figure as indicated below to complete gyroscope calibration. Make sure you do not touch, move or shake AirLeash until calibration process is completed.

Gyro calibration process:

1. Long press (3sec.) on Power/OK button  to power AirLeash on.
2. Short press on the Menu button  to enter the Menu.
3. Navigate through the Menu with arrows   until you see the Settings icon  on the LCD screen.

4. Short press on Power/OK  to enter Settings .
5. Navigate through Settings with arrows   until you see the Calibration icon  on the LCD screen.
6. Short press on Power/OK  to enter Calibration menu.
7. Navigate through Calibration menu with arrows   until you see the AirLeash Calibration icon .
8. Short press on Power/OK  to enter AirLeash Calibration menu.
9. Navigate through AirLeash menu with arrows   until you see Gyro icon  on the LCD screen.



10. Put AirLeash on level surface and short press on Power/OK  .  
You will see a message "Watch video: [help.airdog.com](http://help.airdog.com)", it is strongly advised to go and watch the calibration videos before you calibrate any sensors. Press Power/OK  and you will be forwarded to the next info screen where you can choose to either read more calibration tips (press Power/OK  button to see them) or you can skip the tips by pressing Play/Pause button.
11. Calibration will start after 5 sec., a message stating "HOLD STILL" will appear, do not move AirLeash while this message is visible.
12. You will hear the "success" tone and see the message "Calibration COMPLETED Press OK" short press on Power/OK  to complete calibration process.



If gyroscope calibration fails more than three times (in a row), recalibrate the AirLeash accelerometer. Bad accelerometer calibration can cause gyroscope calibration failure.

# 5. System Preparation

---

## 5.6.2 AirDog Calibration

Please note that all AirDog sensors have been factory-calibrated. Accelerometer and Gyroscope sensors should be recalibrated **ONLY** if AirLeash displays such warning message.

### 5.6.2.1 AirDog Magnetometer (Mag) Calibration ◀











Magnetometer calibration shouldn't be done unless there is a physical sensor replacement or the AirLeash displays such warning message.













The magnetometer is very sensitive to magnetic interferences and its calibration requires an interference-free environment. Stay away

from metal and concrete structures such as buildings, parking or any metal structures. Do not wear gloves or rings with magnets or other ferromagnetic metals while performing the calibration steps.

AirDog is only meant to work outdoors and indoor calibration will lead to faulty measurements.

#### **Magnetometer calibration process:**

1. Insert the battery in the unfolded AirDog.
2. Long press (3sec.) on Power/OK button  to power AirLeash on.
3. Short press on the Menu button  to enter the Menu.
4. Navigate through the Menu with arrows   until you see the Settings icon  on the LCD screen.
5. Short press on Power/OK  to enter Settings .
6. Navigate through Settings with arrows   until you see the Calibration icon  on the LCD screen.

7. Short press on Power/OK  to enter Calibration menu.
8. Navigate through Calibration menu with arrows   until you see the AirDog Calibration icon .
9. Short press on Power/OK  to enter AirDog Calibration menu.
10. Navigate through the AirDog Calibration menu with arrows   until you see Magnetometer icon  on the LCD screen.
11. Strap AirLeash on your forearm with the display visible in order to see messages.
12. Short press Power/OK  and you will see a message "Watch video: [help.airdog.com](http://help.airdog.com)", it is strongly advised to watch the calibration videos before you calibrate any sensors. Press Power/OK  and you will be forwarded to the next info screen where you can choose to either read more calibration tips (press Power/OK  button to see them) or to skip the tips by pressing Play/Pause .
13. Calibration will start after 5 sec., a message stating "Hold AirDog Belly UP" will appear, pick up AirDog from ground and turn "belly up":

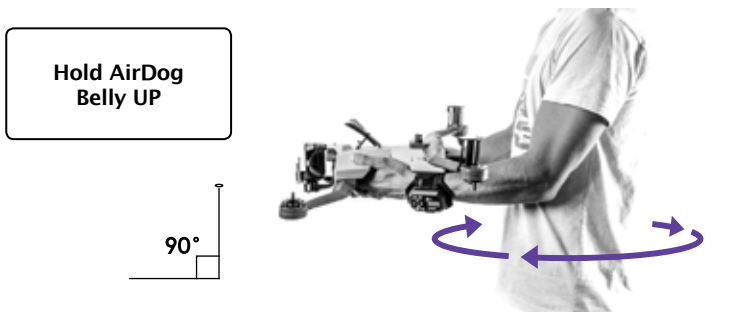

14. Hold AirDog steady at a 90° angle (respective to the ground level) until you see a message: "Rotate AirDog 360 degrees", do not rotate until you see the message.
15. After a full rotation AirDog will display the next message "Hold AirDog Belly DOWN", you'll have to flip AirDog "belly down":

# 5. System Preparation

---

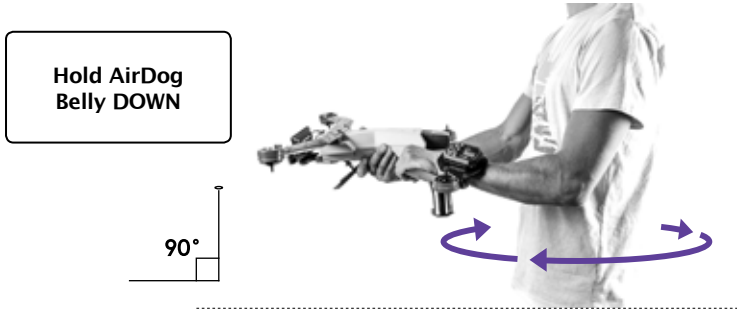

16. Hold AirDog steady at a  $90^\circ$  angle (relative to the ground level) until you see a message: "Rotate AirDog 360 degrees", do not rotate until you see the message.
17. After a full rotation AirDog will display the next message "Hold AirDog Left arms UP", you'll have to turn AirDog so that left arms are up:

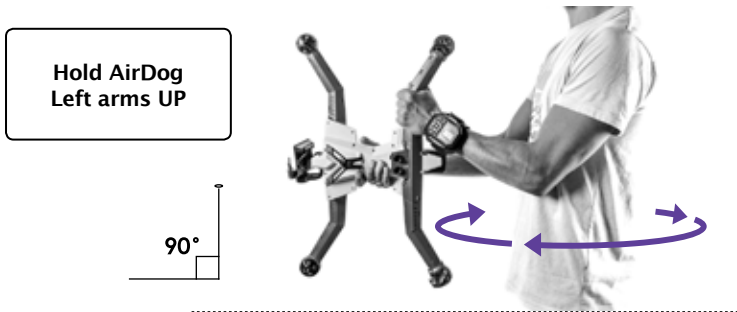

18. Hold AirDog steady at a  $90^\circ$  angle (relative to the ground level) until you see a message: "Rotate AirDog 360 degrees", do not rotate until you see the message.
19. After a full rotation AirDog will display the next message "Hold AirDog Right arms UP", you'll have to turn AirDog so that left arms are up:



**Hold AirDog  
Right arms UP**

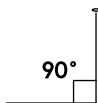

20. Hold AirDog steady at a  $90^\circ$  angle (relative to the ground level) until you see a message: "Rotate AirDog 360 degrees", do not rotate until you see the message.
21. After a full rotation AirDog will display the next message "Hold AirDog Camera UP", you'll have to turn AirDog so that the camera is facing up:

**Hold AirDog  
Camera UP**

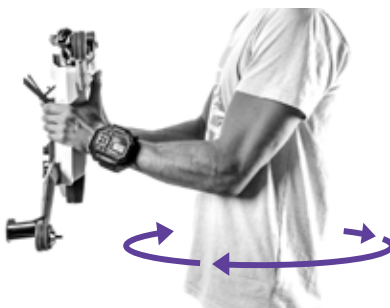
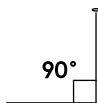

22. Hold AirDog steady and at a  $90^\circ$  angle (relative to the ground level) until you see a message: "Rotate AirDog 360 degrees", do not rotate until you see the message.
23. After a full rotation AirDog will display the next message "Hold AirDog Camera DOWN", you'll have to turn AirDog so that the camera is facing down:

# 5. System Preparation

---

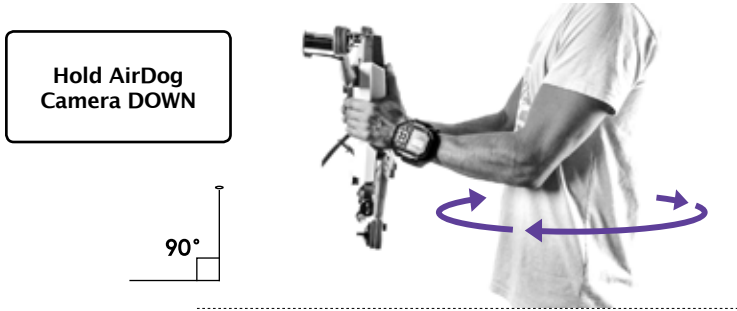





















24. Hold AirDog steady at a 90° angle (relative to the ground level) until you see a message: "Rotate AirDog 360 degrees", do not rotate until you see the message.
25. Continue rotating (even if you don't hear a tone) until you'll hear a "success" tone and see the message "Calibration COMPLETED Press OK" short press on Power/OK  to complete the calibration process.
26. During calibration you may see two error messages:
  - a. If you see "FAILED motion detected hold still or calibrate gyro" restart calibration again and hold AirDog really steady in each position. If the error message appears again calibrate AirDog Gyro and then recalibrate AirDog Magnetometer.
  - b. If you see "FAILED wrong angle" restart calibration again and hold AirDog at a 90° angle (relative to the ground level).

## 5.6.2.2 AirDog Accelerometer (Accels) Calibration >>>

Calibrate Accelerometer on AirDog **ONLY** if you are notified that it is necessary.

Follow the figures as indicated below to complete accelerometer calibration. Make sure to hold AirDog in each Axis position level and steady until it makes a sound and displays the message "Change side and hold still" before moving to the next position.

## Accelerometer calibration process:

1. Insert the battery in the unfolded AirDog.
2. Long press (3sec.) on Power/OK button  to power AirLeash on.
3. Short press on Menu button  to enter Menu.
4. Navigate through Menu with arrows   until you see the Settings icon  on the LCD screen
5. Short press on Power/OK  to enter Settings .
6. Navigate through Settings with arrows   until you see the Calibration icon  on the LCD screen.
7. Short press on Power/OK  to enter Calibration menu.
8. Navigate through Calibration menu with arrows   until you see the AirDog Calibration icon .
9. Short press on Power/OK  to enter AirDog Calibration menu.
10. Navigate through the AirDog menu with arrows   until you see Accels icon  on the LCD screen.
11. Short press Power/OK and you will see a message “Watch video: [help.airdog.com](http://help.airdog.com)”, it is strongly advised to watch the calibration videos before you calibrate any sensors. Press Power/OK  and you will be forwarded to the next info screen where you can choose to either read more calibration tips (press Power/OK  to see them) or skip the tips by pressing Play/Pause .
12. Calibration will start after 5 sec., a message stating “Hold AirDog Camera UP” will appear, tilt up AirDog so that camera is facing up:

**Hold AirDog  
Camera UP**

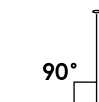

# 5. System Preparation

---

- 13. Hold AirDog steady at a 90° angle (relative to the ground level) a message: "HOLD STILL" will appear, do not move while this message is visible.
- 14. When you hear a different tone and the message "HOLD STILL" changes to the next message "Hold AirDog Camera DOWN", flip AirDog so that camera is facing down:

**Hold AirDog  
Camera DOWN**

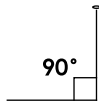

- 15. Hold AirDog steady at a 90° angle (relative to the ground level) a message: "HOLD STILL" will appear, do not move while this message is visible.
- 16. When you hear a different tone and the message "HOLD STILL" changes to the next message "Hold AirDog Left arms UP", rotate AirDog so that the left arms are up:

**Hold AirDog  
Left arms UP**

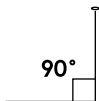

17. Hold AirDog steady at a 90° angle (relative to the ground level) a message: "HOLD STILL" will appear, do not move while this message is visible.
18. When you hear a different tone and the message "HOLD STILL" changes to the next message "Hold AirDog Right arms UP", rotate AirDog so that the right arms are up:

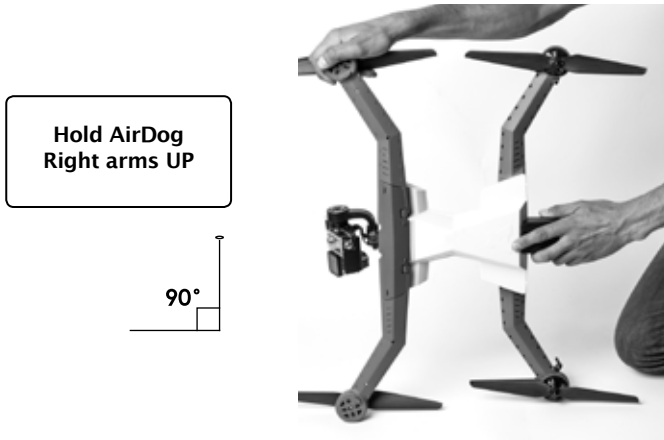

19. Hold AirDog steady at a 90° angle (relative to the ground level) a message: "HOLD STILL" will appear, do not move while this message is visible.
20. When you hear a different tone and the message "HOLD STILL" changes to the next message "Hold AirDog Belly UP", flip AirDog so that the "belly" is facing up and place your arms underneath battery:

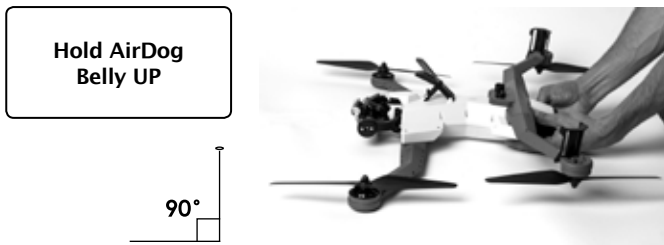

# 5. System Preparation

---

21. Hold AirDog steady (parallel ground level) a message: "HOLD STILL" will appear, do not move while this message is visible.
22. When you hear a different tone and the message "HOLD STILL" changes to the next message "Hold AirDog Belly DOWN", flip AirDog so that the "belly" is facing down:

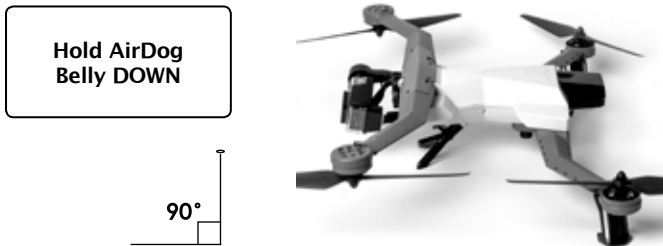





















23. Leave AirDog on a level surface and a message: "HOLD STILL" will appear, do not move while this message is visible.
24. When you hear the "success" tone, AirLeash display will show the message "Calibration COMPLETED Press OK" short press on Power/OK  to complete the calibration process.
25. During calibration you may see two error messages:
  - a. If you see "FAILED motion detected recalibrate and hold still" restart calibration again and hold AirDog really steady in each position.
  - b. If you see "FAILED wrong angle" restart calibration again and hold AirDog at a 90° angle (respective to the ground level).

### 5.6.2.3 AirDog Gyroscope (Gyro) Calibration

Calibrate Gyroscope on AirDog **ONLY** if you are notified that it is necessary.

Follow the figure as indicated below to complete gyroscope calibration. Make sure you do not touch, move or shake AirDog until calibration process is completed.

#### Gyro calibration process:

1. Insert the battery in the unfolded AirDog.
2. Long press (3sec.) on Power/OK button  to power AirLeash on.
3. Short press on Menu button  to enter Menu.
4. Navigate through Menu with arrows   until you see the Settings icon  on the LCD screen.
5. Short press on Power/OK  to enter Settings .
6. Navigate through Settings with arrows   until you see the Calibration icon  on the LCD screen.
7. Short press on Power/OK  to enter Calibration menu.
8. Navigate through Calibration menu with arrows   until you see the AirDog Calibration icon .
9. Short press on Power/OK  to enter AirDog Calibration menu.
10. Navigate through the AirLeash menu with arrows   until you see Gyro  icon on the LCD screen.
11. Short press Power/OK and you will see a message “Watch video: [help.airdog.com](http://help.airdog.com)”, it is strongly advised to watch the calibration videos before you calibrate any sensors. Press Power/OK  and you will be forwarded to the next info screen where you can choose to either read more calibration tips (press Power/OK  button to see them) or you can skip the tips by pressing the Play/Pause .

# 5. System Preparation











---



12. Calibration will start after 5 sec., a message stating "HOLD STILL" will appear, do not move AirDog while this message is visible.
13. When you hear the "success" tone, AirLeash display will show the message "Calibration COMPLETED Press OK" short press on Power/OK  to complete calibration process.
14. During calibration you may see a error message: "FAILED motion detected recalibrate and hold still" restart calibration again.



If you hear a SOS tone (three long beeps followed by three short beeps) right after you have inserted battery, then there is a problem with one or more AirDog sensors. To find out which sensor is faulty please initiate "Sensor check" manually:

1. Long press (3sec.) on Power/OK button  to power AirLeash on.
2. Short press on the Menu button  to enter the Menu.
3. Navigate through the Menu with arrows   until you see the Settings icon  on the LCD screen.
4. Short press on Power/OK  to enter Settings .
5. Navigate through the Menu with arrows   until you see the Sensor Check  icon on the LCD screen.
6. Short press on Power/OK  to initiate Sensor Check. Follow instructions on AirLeash LCD screen.



### 5.6.3 Gimbal Calibration

The gimbal comes to you factory-calibrated. However, you will most likely have to recalibrate it at some point (for example, when filming in low temperatures or when the gimbal is not leveled correctly or drifts in flight).

#### 5.6.3.1 Gimbal Gyroscope (Gyro) Calibration

Follow the figure as indicated below to complete gyroscope calibration. Make sure you do not touch, move or shake the gimbal or AirDog until calibration process is completed. The position of the gimbal does not matter as long as it does not move at all.

AirDog is only meant to work outdoors and indoor calibration will lead to faulty measurements.

#### Gimbal gyroscope calibration process:

1. Insert the battery in the unfolded AirDog and wait until AirDog automatically switches gimbal off.



2. Short press three times the frame button at the rear of AirDog, you will hear three beeps followed by calibration tone. This means that gimbal gyro calibration has started. If you don't hear the calibration tone (you may not have short pressed fast enough).



Gimbal gyro calibration is completed when AirDog stops the beeping tone.

# 5. System Preparation

---

## 5.6.3.2 Gimbal Accelerometer (Accels) Calibration

Follow the figures as indicated below to complete the gimbal accelerometer calibration. Make sure to insert the battery while AirDog is unfolded before you start the calibration process.

Before moving it to the next Axis position, hold the gimbal steady in position until AirDog stops beeping.

You should leave the camera in its housing when performing the calibration process (turn off camera).

AirDog is only meant to work outdoors and indoor calibration will lead to faulty measurements.

### Gimbal accelerometer calibration process:

1. Insert the battery in the unfolded AirDog and wait until AirDog automatically switches gimbal off.
2. Position the gimbal in the **1st Axis position\*** hold the gimbal level and really steady and then **short press twice** the frame button. You will hear two beeps, after which you will hear calibration tone.



**1st Axis position**  
Camera pointing forward

---

\*When calibrating gimbal accelerometer always start calibration with 1st Axis.



The calibration of the axis is completed when the calibration tone stops. You can then only move to the next axis. If you don't hear the calibration tone (you may not have short pressed fast enough) just try again.

3. Repeat the step 2 for each remaining axis position.



**2nd Axis position**  
Camera on right side



**3rd Axis position**  
Camera on left side



**4th Axis position**  
Camera facing up

# 5. System Preparation

---



**5th Axis position**  
Camera facing down



**6th Axis position**  
Camera upside down

Gimbal Calibration will fail if you don't hold it in each position and you may have to start the process again from the beginning.

You can check if the calibration is good by removing and inserting back AirDog's battery. The gimbal should stand in a normal position (horizon is level).

If the gimbal does not stand in a normal position and slowly drifts to either side or is shaking rapidly, you must start the process again from the beginning.

---

Note that gimbal will automatically switch off after 10sec after battery insertion.

Depending on where and how you fly, you could be unknowingly risking the safety of people around you. That's not something to be taken lightly and this is why safety is the first measure to consider. By following these tips for drone safety and sticking closely to the existing rules, users can make sure they enjoy all the benefits of flying a drone without causing any problems.

# 6. Safety

---

## 6.1 Know Your Surroundings And Flight Safety

### 6.1.1 Pre-Flight Checklist

We recommend you go through the Pre-Flight Checklist before each flight:

- ⓘ · Propellers are tightly attached and not damaged or bent.
- Check if all motor retaining rings are in place.
- Check if all motors are spinning freely.
- AirDog body and arms are not damaged and there are no visible cracks.
- Check if LIDAR lenses are clean from dirt or snow.
- AirDog battery is fully charged, not swollen and it is securely inserted.
- AirLeash battery is fully charged and AirLeash is securely attached around the wrist or upper arm.
- GoPro camera is securely locked in place turned on and Wi-Fi is disabled.
- Landing gears are oriented down.
- Takeoff location: place AirDog on safe level surface.
- Make sure that altitude difference between AirLeash and AirDog does not exceed 6-7 feet (2 meters).
- Weather conditions: wind is less than 28 knots (15 meters per seconds, 32 miles per hour, 52 kilometers per hour), not raining, foggy or snowing.
- Fly at least 5 miles (8 km) away from nearest airports and/or controlled airspace.
- To see all the safety guidelines, check: [knowbeforeyoufly.org/for-recreational-users](http://knowbeforeyoufly.org/for-recreational-users)

# 6. Safety

---

## 6.1.2 Pre-Flight Requirements

- ⚠️ • Rotating propellers can cause serious injury. Never initiate takeoff from your hand. Do not try to grab AirDog before it lands automatically on the ground and before the propellers are switched off and stop rotating.
- Do not fly AirDog indoors or at night. Always fly outside in open areas.
- AirDog is not set up for obstacle avoidance and you must ensure there are no obstacles in the flight area that could disturb the flight, such as: trees, crowds, bodies of water, buildings or high voltage power lines.
- Check the weather conditions and do not fly AirDog when the weather is windy, rainy, snowy, foggy, or when visibility is limited. These include wind speed exceeding 28 knots (15 meters per second, 32 miles per hour, 52 kilometers per hour).
- Reduce the chance of electromagnetic interference by not flying AirDog in areas with significant high levels of electromagnetism such as base stations, radio towers or on-board radio transmission equipment.
- Do not use AirDog under the influence of medications, drugs or alcohol.
- Drones should always be kept away from police operations, accident scenes, building fires and rescue operations as there is a serious risk of mid-air collision with an aircraft or a helicopter, which could cause an accident.

## 6.1.3 Flight Location & Prohibited Takeoff Locations

- ⚠️ • Ensure that the use of AirDog is authorized in your flight area and at a safe distance of 25 feet (7 meters) away from individuals, vulnerable property, persons and animals.
- Do not initiate takeoff from a boat or a moving platform. Even for very large ships, a boat is always moving. To perform its initialization, it is mandatory that AirDog remains completely motionless for a few moments. Such requirements are impossible on a moving platform like the deck of a boat.

## 6.1.4 Flight Limits

- ⓘ · AirDog may not operate within 5 miles (8 km) of an airport or within any restricted airspace.
- FAA regulations require that Small Unmanned Aircraft Systems (sUAS) users may not operate their sUAS at an altitude of no more than 400 feet (120 meters) above ground level. Be aware that by default the maximum flight altitude for AirDog cannot exceed an altitude of 400 feet (120 meters).
- FAA regulations require that Small Unmanned Aircraft Systems (sUAS) users may not operate their sUAS at a speed exceeding 87 knots (100 miles per hour, 160 kilometers per hour). Be aware that by default the maximum flight speed for AirDog cannot exceed a speed of 38 knots (20 meters per second, 44 miles per hour, 70 kilometers per hour).

## 6.1.5 Laser Warning

- ⓘ · AirDog is equipped with a downward LIDAR sensor (circular lenses under the drone) which is a remote sensing technology that measures distance between AirDog and the ground by illuminating a target with a laser and analyzing the reflected light. Lidar prevents downward collisions should you suddenly descend too fast. Meaning, if you take a steep drop on a mountain bike, AirDog won't bounce off the rocks.
- The laser beams emitted by the LIDAR sensor can damage the retinas permanently. This is why it is important to take further security measures by never pointing the LIDAR sensor at anyone's face or eyes.

# 7. Flight

---

- ⓘ Remember that AirDog is intended only for outdoor use in wide open places with a clear view of the sky, because AirDog requires a strong GPS signal to fly autonomously.

A clear view of the sky will produce the highest satellite count and the best accuracy. Obstructions such as trees, buildings and mountains, electromagnetic interference from radio towers, or onboard radio transmission equipment, or the time of day, can reduce the quality of GPS.

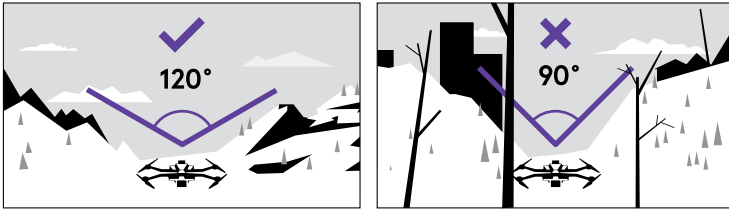

## 7.1 Before Flight

- Place AirDog and AirLeash on a level surface as shown below in order to acquire GPS lock and verify AirDog and AirLeash sensors (Sensor check).



- Insert the AirDog battery\* while AirDog arms are unfolded and long press (3sec.) on Power/OK button  on AirLeash to power AirLeash\*\* on.



---

\*Check if AirDog battery is fully charged by pressing the status button on the battery.





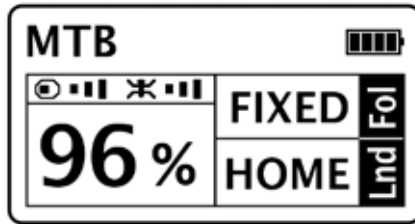



\*\*Refer to “AirLeash Buttons” on paragraph 4.2.4 for more information.

- Check if you have selected appropriate sport mode before you takeoff, since you won't be able to change or customize it once AirDog is airborne. You can see the selected sport mode in the main screen upper left corner:





Your selected sport mode will flash on the upper left corner and change between “Getting GPS” or “READY” statuses.

#### To select a Sport Mode:

1. Short press on the Menu button  to enter the Menu.
2. Navigate through the Menu with arrows   until you see the Sport Modes icon  on the LCD screen.
3. Short press on Power/OK  to enter Sport Modes  menu.
4. Navigate through the Sport Modes with arrows   until you see your Sport Mode\* on the LCD screen.
5. Short press on Power/OK  twice to select the Sport Mode.

#### To customize selected Sport Mode:







1. Short press on the Menu button  to enter the Menu.
2. Navigate through the Menu with arrows   until you see the “Customize” on the LCD screen.

---

\*Refer to the Sport Modes selection on paragraph 4.6.1 for more information.

# 7. Flight

---

3. Short press on Power/OK  to enter current Sport Mode customization.
4. Navigate through the different parameters (takeoff altitude, landing mode, etc.) with arrows   and adjust each parameter by pressing  .
5. After you have adjusted all parameters short press on the Menu button  and a "SAVE" text will appear.
6. Short press on Power/OK  to confirm the parameter save.





## 7.1.1 Sensor Check

Sensor check is a procedure that verifies if AirDog and AirLeash sensors are ok to fly. Sensor check will be initiated automatically after AirDog and AirLeash get a good GPS lock. You will have to do it only once a day.

The procedure consists of two parts, first you check if AirDog sensors are ok, after that you check AirLeash sensors.

**Step 1:** Turn ON AirDog and AirLeash. Place AirDog on a level surface in front of you so that the "Camera pointing left from you":



Wait until you see the message: "AirDog sensor check required Press OK" short press Power/OK  and you will see a message "Watch video: [help.airdog.com](http://help.airdog.com)", it is strongly advised to watch the sensor check video. Press Power/OK  and you will be forwarded to the next info screen where you can choose to either read more sensor check tips (press Power/OK  to see them) or skip the tips by pressing Play/Pause .

**Step 2:** You will see the message "wait" when you see this message please do not move AirDog.

**Step 3:** Once you hear a beeping tone, and see the message: "Rotate 90 degrees as shown", turn AirDog 90 degrees to the right (clockwise). Do this in a smooth and controlled motion:

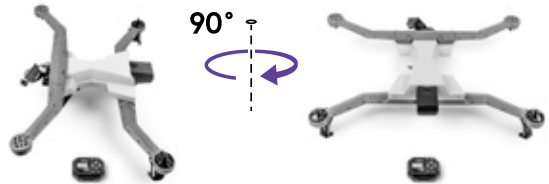
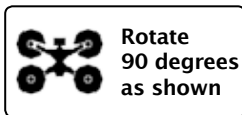

**Step 4:** Once you hear the second quick beep after rotating AirDog 90 degrees clockwise, and AirLeash displays the message "Roll right with left arms up", pick up AirDog and tilt AirDog upwards, resting perpendicular to the ground with the right front and back arms are resting on the ground:

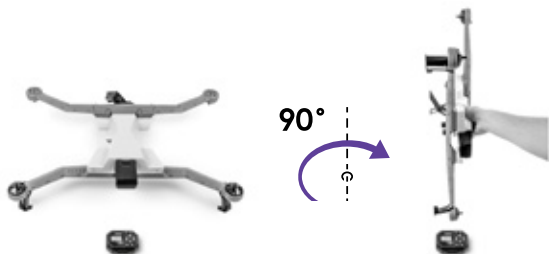
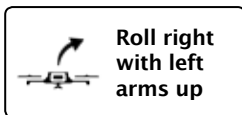

# 7. Flight

---



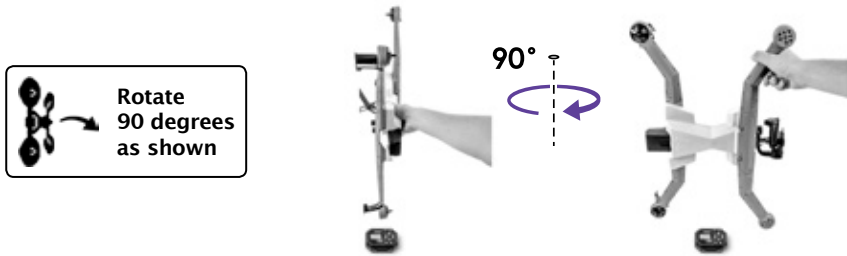

**Step 5:** Once you hear the next beep and AirLeash displays the message “Rotate 90 degrees as shown”, keeping AirDog vertical (right front and right back arm resting on the ground) turn AirDog 90 degrees clockwise and keep AirDog as still and as straight as possible:



If you hear the “success” tone AirDog sensors are ok to fly, but if you hear the “failed” tone you will see an error message which will tell you what needs to be done:

- **AirDog tilted try again or calibrate accel** – the surface on which you placed AirDog isn’t level enough, reposition AirDog and try sensor check again, if you see this message again and you are sure that the surface is level, then only calibrate AirDog Accels.
- **Vibrations detected try again or calibrate gyro** – try sensor check again, if you get the same error message calibrate AirDog gyro.
- **Vibrations detected try again or calibrate accel** – try sensor check again, if you get the same error message calibrate AirDog accel.
- **Vibrations detected try again or calibrate mag** – try sensor check again, if you get the same error message calibrate AirDog mag.
- **Calibrate Gyro** – please calibrate AirDog Gyro.
- **Calibrate Accel** – please calibrate AirDog Accel.

- **Calibrate Magnetometer** – please calibrate AirDog Magnetometer.
- **Hardware error contact support / Magnetometer error contact support / Gyro error contact support / Accel error contact support** – if you get this error message please contact support through AirLoader app and mention this error message.

**Step 6:** after successful AirDog sensor check you will see the message: “AirLeash sensor check required Press OK” short press Power/OK  and you will see a message “Watch video: [help.airdog.com](http://help.airdog.com)”, it is strongly advised to watch the calibration videos before you calibrate any sensors. Press Power/OK  and you will be forwarded to the next info screen where you can choose to either read more sensor check tips (press Power/OK  to see them) or skip the tips by pressing Play/Pause  .

Put AirLeash on a level surface and short press Power/OK  . You will see message: “wait” while you see this message please do not move AirLeash.

If you hear the “success” tone and don’t see any error messages, AirLeash sensors are ok to fly, but if you hear the “failed” tone you will get an error message which will tell you what needs to be done. Please check the error message definitions previously listed.

# 7. Flight

---

## 7.2 Takeoff

- Make sure that you and AirLeash are on the same altitude as AirDog before initiating takeoff.
- Wait until you see the “READY” message displayed on AirLeash LCD screen left upper corner, and AirDog LED’s turn from blinking to solid lights.

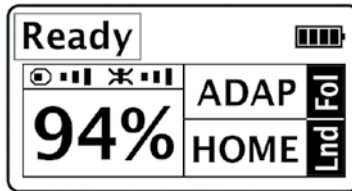

- Initiate takeoff by short pressing Play/Pause button ▶ || and confirming the action with short press on Power/OK button .
- AirDog will ascend until takeoff altitude\* is reached.
- AirDog will turn the camera at AirLeash and stay in the current position in “Hover & Aim” mode\*\*.

---

\*Takeoff altitude can be adjusted, via the AirLeash menu or the AirDog app.

\*\*AirDog will stay in “Hover & Aim” mode if you have not activated the “Follow immediately” function via AirLeash or AirDog mobile app.

- ⚠ Rotating propellers can cause serious injury. Never command or initiate AirDog to take off from your hand or while holding AirDog.

## 7.3 AirDog Inflight Controls Via AirLeash

### 7.3.1 Altitude Adjustment

You can increase or decrease AirDog's altitude by pressing arrows ▲ (up) and ▼ (down) on AirLeash while in air.

If you press the arrow ▲ (up) once, AirDog will increase its altitude by 2 meters (7 feet), but if you long press (3sec.) the arrow ▲ (up) AirDog will increase its altitude until you short press Power/OK  button or until it reaches the max altitude.

If you press the arrow ▼ (down) once, AirDog will decrease its altitude by 1 meter (3 feet), but if you long press (3sec.) arrow ▼ (down) AirDog will decrease its altitude until you short press on Power/OK  button or until it reaches the min altitude from ground (5 meters or 16 feet).

### 7.3.2 Change Angle

You can reposition AirDog clockwise (to the right) or counterclockwise (to the left) around your position\*:

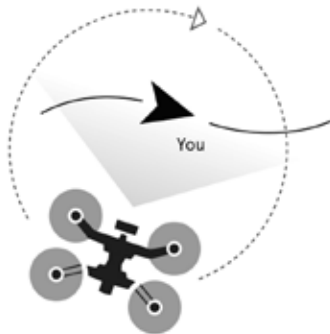

# 7. Flight

---



To reposition AirDog clockwise ► (to the right) press arrow (right) once and AirDog will change its position by 1 meter (3 feet), but if you long press (3sec.) arrow ► (right) AirDog will rotate around you clockwise until you short press on Power/OK  button.

To reposition AirDog counterclockwise (to the left) press arrow ◀ (left) once and AirDog will change its position by 1 meter (3 feet), but if you long press (3sec.) arrow ◀ (left) AirDog will rotate around you counterclockwise (to the left) until you short press on Power/OK  button.

---

\*You won't be able to reposition AirDog clockwise or counterclockwise in Sport Modes that include one of the following modes: Follow line, please refer to paragraph 4.6.1. for more information to find out which are these Sport Modes.

## 7.3.3 Farther & Closer

You can reposition AirDog farther or closer to your position, by entering "Joystick" mode. To enter "Joystick" mode\*, short press the Menu button  on AirLeash. A Joystick symbol  will appear on the AirLeash LCD screen.

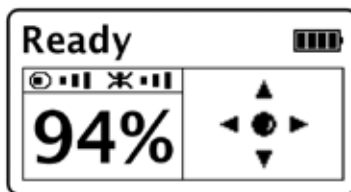





In "Joystick" mode press the arrow ▲ (up) once and AirDog will reposition farther away from you by 1 meter (3 feet), but if you long press (3sec.) the arrow ▲ (up) AirDog will move farther away from you until you short press Power/OK  button or until it reaches the distance of 50 meters (170 feet).

In "Joystick" mode press the arrow ▼ (down) once AirDog will come closer to you by 1 meter (3 feet), but if you long press (3sec.) the arrow ▼ (down) AirDog will come closer to you until you short press Power/OK  button or until it reaches the min distance 5 meters (16 feet).

### 7.3.4 Play / Pause Follow

To start or stop the auto-follow function (depending on your selected Sport Mode and follow mode) press Play/Pause button  on AirLeash.



Note that after pressing Play/Pause button  , AirDog will automatically reposition (fly backwards) to reach the preset follow distance.

### 7.3.5 Come To Me (CTM)

You can "call" AirDog to your position with a short press of the CTM button  on AirLeash. AirDog will immediately fly over in a straight line and initiate "Hover & Aim" mode over the position where CTM was initiated.

If you initiate CTM when you are at a higher altitude than AirDog (you're higher up the mountain), AirDog will ascend until it reaches the initial takeoff altitude offset (your current altitude + takeoff altitude offset) and only then will AirDog fly over in a straight line.

If you initiate CTM when you are at a lower altitude than AirDog (you're lower down the mountain), AirDog will fly over in straight line to your position and then only descend to the takeoff altitude offset.

# 7. Flight

---

## 7.4 Landing

There are two ways to land AirDog – SPOT and HOME landing. SPOT landing means that AirDog will land in the current AirDog position. HOME landing means that AirDog will ascend to the preset “Return altitude”, then fly in straight trajectory to the takeoff point and land. In water Sport Modes it won’t be possible to land on SPOT to avoid accidentally landing in water.

To initiate **SPOT landing** – short press the  button on AirLeash.

To initiate **HOME landing** – long press (3sec.) the  button on AirLeash.

AirDog will initiate an auto landing sequence, depending on your chosen Sport Mode\* and selected landing mode when certain battery level is reached.

You can **stop and resume the landing sequence** by short pressing Play / Pause button  on AirLeash. But if AirDog’s battery level is critical this action will not be available.

If you have selected HOME landing before the flight and AirDog’s battery level drops below 30% during the flight, AirDog will automatically initiate the Return to Home (HOME) landing sequence.

If you have selected SPOT landing before your flight and AirDog’s battery level drops below 20% during the flight, AirDog will automatically initiate the SPOT landing sequence.

Depending on your surroundings, you can adjust the Return to Home (HOME) altitude manually via the AirDog mobile app or by short pressing the Menu button  on AirLeash. Select “Customize” (your currently selected Sport Mode) and then navigate through the parameters until you find “Return altitude”.

---

\*Each Sport Mode preset has its own predefined landing mode, please check the full Sport Mode descriptions in section 4.6.1.

 The rotating propellers can cause serious injury. Do not try to grab AirDog before it lands automatically on the ground and propellers are switched off.

# 8. Software Update Via Desktop App AirLoader

---

For the best user experience, we recommend you regularly connect your AirDog and AirLeash to our desktop app (AirLoader) to check if your devices have the latest firmware. Firmware updates will fix any bugs or problems which AirDog/AirLeash has identified and may also bring new features such as new Sport Modes, etc.

Download and install the latest AirLoader version.

You can get it here: <https://www.airdog.com/support>



Before your first flight, use the AirLoader desktop app to perform the required first-flight update.

# 9. Appendix

---

## 9.1 Specifications

| AirDog   |   |
|--|---|
| Height:  | 5.39 in. (13.7 cm)  |
| Motor-to-motor dimension:                              | 24.68 in. (62.7 cm)   |
| Weight (battery, propellers, camera excluded):         | 4.12 lbs. (1.872 kg)  |
| Approx. Weight (battery, propellers, camera included): | 4.41 lbs. (2.003 kg)  |
| Motor:   | Brushless   |
| Propeller:   | 11.02 in. x 1.06 in.<br>(28 cm x 2.7 cm)<br>Left arms: black nuts<br>Right arms: black nuts and white stripes |
| Battery:   | Interchangeable 14.8V, 5600 mAh, lithium polymer battery  |
| Range Maximum speed:                                   | 38 knots (44 miles per hour, 70 kilometers per hour).   |
| Maximum flight altitude:                               | 11,500 feet (3,500 meters) above sea level  |
| Range:   | 400 feet (120 meters)   |
| Wind limitation:                                       | 28 knots (14 meters per second)   |
| Estimated flight time:                                 | 10-18 min. depending on flight speed, wind conditions   |
| Operating temperature range:                           | 23°F - 104°F (-5°C to 40°C).  |
| Operating relative humidity range:                     | 0-85% RH  |

### AirLeash

|                                    |  |
|------------------------------------|--|
| Dimension:                         | 2.99 in. x 2.36 in. x 0.82 in.<br>(76 mm x 60 mm x 2.1 mm) |
| Weight:                            | 0.17 lbs. (0.08 kg)  |
| Battery:                           | Rechargeable 3.7V, 450mAh, lithium polymer battery         |
| Flight Time:                       | 2 hours (6 to 10 flights)                                  |
| Standby time:                      | 2 min.   |
| Charge time:                       | 2 hours  |
| IP rating:                         | IP67<br>Submersible up to 1 meter for 30 min.              |
| Charging port:                     | Micro USB  |
| Frequency type:                    | Long range Bluetooth                                       |
| Range:                             | 820 feet (250 meters)                                      |
| Operating temperature range:       | 23°F - 104°F (-5°C to 40°C).                               |
| Operating relative humidity range: | 0-85% RH   |

### AirDog Battery

|                              |  |
|------------------------------|--|
| Dimension:                   | 6,85 in. x 2.08 in. x 1.77 in.<br>(174 mm x 53 mm x 45 mm) |
| Type:                        | Interchangeable 14.8V, 5600 mAh, lithium polymer battery   |
| Weight:                      | 1.05 lbs. (0.48 kg)  |
| Energy:                      | 82.88Wh  |
| Operating temperature range: | 23°F - 104°F (-5°C to 40°C).                               |
| Maximum charging power:      | 82.88W, 5.6 A  |

### AirDog Charger

|              |           |
|--------------|-----------|
| Voltage:     | 100~240 V |
| Rated Power: | Out 55W   |

# 9. Appendix

---

## 9.2 Warranty

### 9.2.1 What Is Covered And For How Long?

AirDog warrants the original purchaser of this product against defects in material or workmanship for the warranty period of one year, or such longer period as is required by applicable law when purchased directly from AirDog or AirDog authorized retailer. This warranty is not transferable or assignable.

Pursuant to this limited warranty and without charge for parts or labor directly related to the defect(s), AirDog will, at its option, 1. repair the product using new or refurbished parts or 2. replace the product with a new or refurbished product within a reasonable period of time and free of charge. "Refurbished" means a product or part that has been returned to its original specifications.

This limited warranty only covers product issues caused by defects in material or workmanship during ordinary consumer use for the period commencing upon the date of purchase and continuing for the following specified period of time after that date.

| Warranty Periods<br>(or such longer period as is required by applicable law) |   |               |
|--|---|---------------|
| 1 year   | 6 months  | No warranty   |
| AirDog Drone,<br>AirLeash  | Battery, Battery<br>Charger, Propeller<br>Motors, Gimbal Motors | Plastic Parts |

AirDog will not pay shipping, insurance or transportation charges from you to us, or any import fees, duties and taxes.

## 9.2.2 What Is Not Covered?

This limited warranty is conditioned upon proper use of the product by the purchaser and it does not cover product issues caused by any other reason, including but not limited to:

1. Acts of God,
2. Misuse despite of the guidance of user manuals,
3. Abnormal environmental or weather conditions (i.e. strong wind, rain, snow, storms, sand/dust storm, etc.),
4. Improper storage resulting in exposure to moisture or dampness,
5. Unusual physical, electrical or electromechanical stress,
6. Defects or damage from external causes (i.e. proximity or exposure to heat, electromagnetic interferences, interferences with other wireless devices, improper use of any electrical source, battery leakage, blown fuse, etc.),
7. Accidents caused by non-manufacturing factors (i.e. collision with another object, crash or fire, etc.),
8. Unauthorized opening, modification of or to any part of the product or product purchased which did not follow the instruction of official manuals,
9. Unauthorized opening, modification from other than AirDog or AirDog authorized retailers,
10. Malfunction results from the use of the product in conjunction with accessories, products, services, software or peripheral equipment not expressly approved or provided by AirDog,
11. Improper use of battery, battery charger, battery connector or USB connector,
12. Commercial use,
13. Damage caused by operating the product with a battery that is running low or defective,
14. Damage caused by any set up and/or use which does not carefully respect the instruction manual which contains instructions for safety, operation and maintenance,
15. Damage caused by viruses or other software problems introduced into the product,
16. Use in violation of existing and futures laws, codes and ordinances; confiscation or damage due to such violations.
17. Unauthorized use for rental, military or commercial purposes.

# 9. Appendix

---

This limited warranty does not apply to any non-AirDog products or software. Third-party manufacturers, suppliers, or software publishers, other than AirDog, may provide their own warranties to the purchaser.

This limited warranty is void when there is a damage caused by AirDog aerial drone or the loss of the AirDog aerial drone resulting from the selection, customization or use of a sport flying mode which does not strictly correspond to the sport which is effectively performed by the user.

Except as provided in this limited warranty and to the maximum extent permitted by law, Airdog shall not be liable for any incidental or consequential damages for breach of any express or implied warranty on this product, including injury, death, loss, or other claim related to or resulting from the use of this product. In no event shall company's liability exceed the purchase price of the product.

Some states (countries and provinces) do not allow the exclusion or limitation of incidental or consequential damages, or allow limitations on how long an implied warranty lasts, so the above limitation or exclusion may not apply to you. This limited warranty gives you specific legal rights and you may have other rights which vary from state to state.

**Please check our website on a regular basis for user warranty updates.**

## 9.3 Compliance

### 9.3.1 FCC Compliance

AirDog drone, model: AD10  
Contains  
FCC ID: 2AF4R-BT10, FCC ID: PI4BL600



AirLeash controller, model: AL10

Contains

FCC ID: 2AF4R-BT10

This device complies with Part 15 of the FCC rules. Operation is subject to the following two conditions:

1. This device may not cause harmful interference, and
2. this device must accept any interference received, including interference that may cause undesired operation.

Changes or modifications not expressly approved by AirDog could void the user's authority to operate the equipment.

#### **FCC Radiation Exposure Statement:**

The AirDog equipment has been tested and complies with FCC radiation exposure limits set forth in an uncontrolled environment and meets the FCC radio frequency (RF). The AirDog equipment should be installed and operated with minimum distance 20cm between the radiator and your body. This transmitter must not be co-located or operating in conjunction with any other antenna or transmitter.

This equipment complies with part 15 of the FCC Rules. Operation is subject to the condition that this device does not cause harmful interference.

#### **FCC Rules, Part 15. Warning:**

This equipment has been tested and found to comply with the limits for a class B digital device, pursuant to Part 15 of the FCC rules. These limits are designed to provide reasonable protection against harmful interference in a residential installation. This equipment generates, uses and can radiate radio frequency energy and, if not installed and used in accordance with the instructions, may cause harmful interference to radio communications. However, there is no guarantee that interference will not occur in a particular installation. If this equipment does cause harmful interference to radio or television reception, which can be

# 9. Appendix

---

determined by turning the equipment off and on, the user is encouraged to try to correct the interference by one or more of the following measurements:

- Reorient or relocate the receiving antenna
- Increase the separation between the equipment and receiver
- Connect the equipment to an outlet on a circuit different from that to which the receiver is connected
- Consult the dealer or an experienced radio/TV technician for help

## 9.3.2 IC RSS Compliance

AirDog drone, model: AD10

Contains

IC: 20698-BT10, IC: 1931B-BL600

AirLeash controller, model: AL10

Contains

IC: 20698-BT10

This device complies with Industry Canada license-exempt RSS standard(s). Operation is subject to the following two conditions:

1. this device may not cause interference, and
2. this device must accept any interference, including interference that may cause undesired operation of the device.

Le présent appareil est conforme aux CNR d'Industrie Canada applicables aux appareils radio exempts de licence. L'exploitation est autorisée aux deux conditions suivantes :

1. l'appareil ne doit pas produire de brouillage, et
2. l'utilisateur de l'appareil doit accepter tout brouillage radioélectrique subi, même si le brouillage est susceptible d'en compromettre le fonctionnement.

### IC Radiation Exposure Statement:

The AirDog equipment has been tested and complies with IC RF radiation exposure limits set forth in an uncontrolled environment. The AirDog equipment should be installed and operated with minimum distance 20cm between the radiator and your body. This transmitter must not be co-located or operating in conjunction with any other antenna or transmitter.

Changes or modifications not expressly approved by Airdog could void the user's authority to operate the equipment.

### Avertissement IC à l'Exposition Aux Rayonnements:

L'équipement AirDog a été testé et est conforme aux limites d'exposition IC RF aux rayonnements fixées pour un environnement non contrôlé. L'équipement AirDog doit être installé et utilisé en gardant une distance de 20 cm ou plus entre le dispositif rayonnant et le corps. Ce transmetteur ne doit pas être placé ou utilisé avec une autre antenne ou un autre transmetteur.

Les changements ou modifications non explicitement approuvés par AirDog pourraient annuler l'autorité de l'utilisateur pour utiliser cet équipement.

### 9.3.3 EC Declaration Of Conformity

---

|                           |  |
|---------------------------|--|
| Manufacturer,<br>address: | Airdog LLC. / SIA "Airdog"<br>9A-2, Aristida Briana street, Riga, LV-1001,<br>Latvia<br><a href="http://www.airdog.com">www.airdog.com</a> |
| Product Name,<br>model:   | Auto-follow drone set for GoPro camera.<br>Model: AD10.  |
| Trademark:                |   |

---

# 9. Appendix

---

|                             |   |
|-----------------------------|---|
| Regulations:                | Directive 2006/95/EC of the European Parliament and of the Council of 12 December 2006 on the harmonisation of the laws of Member States relating to electrical equipment designed for use within certain voltage limits.   |
|                             | Directive 2004/108/EC of the European Parliament and of the Council of 15 December 2004 on the approximation of the laws of the Member States relating to electromagnetic compatibility and repealing Directive 89/336/EEC.<br>Directive 2011/65/EU of the European Parliament and of the Council of 8 June 2011 on the restriction of the use of certain hazardous substances in electrical and electronic equipment (RoHS). |
| Used standards:             | LVS EN 60950-1:2006+A11:2009+<br>A1:2010+A12:2011+A2:2013, LVS EN<br>55032:2012+AC:2013+AC:2014, LVS EN<br>55024:2011, ETSI EN 301 489-1 V1.9.2 (2011-09)   |
| Confirmation of conformity: | EC Certificates of Conformity No. 2-060-067/2015 dated October 16 2015 (ICQC Ltd. Notified Body No.2549 Accredited body No.LATAK-S1-499)  |
| Test report references:     | LVD Test report No. 1510834523E/45053/TR/15 dated October 12 2015,<br>TÜV Nord Baltik Ltd. (Accredited Body No. LATAK-T-177)<br>EMC Test report No. LEITC-TR-15-79 dated September 17 2015, Latvian Electronic Equipment Testing Center Ltd. (Accredited Body No. LATAK-T-397)  |

---

I, the undersigned, representing the manufacturer's, declare in sole responsibility, that the product specified above, to which this declaration relates, conforms to the above mentioned Directives and Standards.

Edgar Rozental, CEO



This product carries the CE Mark, which was first applied in 2015.

Date and place of issue:  
October 20, 2015, Riga, Latvia

## 9.4 Manufacturer's Disclaimer Statement

The information in this document is subject to change without notice and does not represent a commitment on the part of the vendor. No warranty or representation, either expressed or implied, is made with respect to the quality, accuracy or fitness for any particular purpose of this document. The manufacturer reserves the right to make changes to the content of this document and/or the products associated with it at any time without obligation to notify any person or organisation of such changes. In no event will the manufacturer be liable for direct, indirect, special, incidental or consequential damages arising out of the use or inability to use this product or documentation, even if advised of the possibility of such damages.

